

<https://daikin-p.ru>

**DAIKIN**  
**Marine type**  
**Container Refrigeration Unit**

---

**Service manual**

**Model**

**LKE8CD16**

 **DAIKIN INDUSTRIES LTD**

**TR86-26**

<https://daikin-p.ru>

This manual describes the features, functions, operation, and maintenance of the container refrigeration unit. In addition, the manuals listed below are also available.

- Parts list

- Compressor disassembly & reassembly manual

Please refer also to these manuals.

## **DANGER**

Do not disconnect plug until power supply is shut off.

## **CAUTION**

Do not start the unit until a plug is connected and generator plant is operated.

## **NOTE**

1. Confirm the function of the temperature recorder and life of the battery when the chart paper is replaced with a new one.
2. Firmly tighten the cover of the control box not to make water ingress.
3. Confirm that the stop valves in the refrigeration circuit are opened before operation.
4. Confirm that the cargos are cooled down to the temperature for transportation in advance.
5. After operating the container refrigeration unit for service, wash the unit with fresh water, especially the external section of the unit carefully, because much salt sticks on the unit.

<b>1. Specification</b>	<b>3</b>
1.1 General specification	3
1.2 Set values of functional parts	4
1.3 Construction	5
(1) Outside	5
(2) Inside	6
(3) Control box	7
1.4 Piping diagram	8
1.5 Wiring diagram	9
1.5.1 Sequence wiring	9
1.5.2 Actual wiring	10
1.5.3 How to read wiring diagram	12
<b>2. Operation</b>	<b>14</b>
2.1 Preparation and operation	14
2.2 Checking during operation	16
2.3 Maintenance after operation	16
<b>3. Operating modes and circuits</b>	<b>17</b>
3.1 Voltage selection system (switching over 200V and 400V class)	17
3.2 Frozen operation	18
3.3 Chilled operation-capacity control	20
3.4 Heating operation	21
3.5 Defrost operation	22
3.6 High pressure control	22
3.7 Air cooled and water cooled operation	23
3.8 Pilot lamps and monitoring circuit	24
<b>4. Major components and maintenance</b>	<b>25</b>
4.1 Components related with refrigeration circuit	25
4.1.1 Compressor	25
4.1.2 Air cooled condenser and evaporator	25
4.1.3 Water cooled condenser	25
4.1.4 Accumulator-receiver with heat exchanger	26
4.1.5 Expansion valve	26
4.1.6 Liquid/moisture indicator	27
4.1.7 Dryer	28
4.1.8 Solenoid valves	29
4.2 Components related with the air system	30
4.2.1 Fans and motors	30
4.2.2 Ventilator	30
4.3 Temperature control system	31
4.3.1 Electronic controller (DECOS I)	31
4.3.2 Modulating control valve (20M)	43
4.3.3 Recorder (SKM-2924A)	44
4.4 Description on electrical and functional parts	48
4.4.1 Dual pressure switch (63HL)	48
4.4.2 High pressure control pressure switch (63CL)	49
4.4.3 Oil pressure switch (63QL)	50
4.4.4 Water pressure switch (63W)	50
4.4.5 Defrost thermistor (TH1)	50
4.4.6 Over-heat thermistor (TH2)	51
4.4.7 Electric heaters	51
4.4.8 Air pressure switch (63DA)	51

<b>5. Operating pressure and running current</b>	<b>52</b>
<b>6. Troubles and countermeasures</b>	<b>53</b>
<b>7. PTI (Pre Trip Inspection)</b>	<b>55</b>
<b>8. How to maintenance</b>	<b>56</b>
<b>8.1 Handling method of the stop valve</b>	<b>56</b>
<b>8.2 Attaching or removing points of pressure gauge</b>	<b>57</b>
<b>8.3 Pump down</b>	<b>58</b>
<b>8.4 Charging and purging the refrigerant</b>	<b>59</b>

## 1. Specification

### 1.1 General specification

Power supply	AC 200V 3 Phase 50 Hz AC 200V, 220V 3 Phase 60 Hz AC 380~415V 3 Phase 50 Hz AC 400V, 440V 3 Phase 60 Hz (Dual voltage rating with voltage selector switch)
Compressor	Semi hermetic type (5.5 kW)
Evaporator	Cross finned coil type
Air cooled condenser	Cross finned coil type
Water cooled condenser	Hairpin-shaped tube-in-tube type
Accumulator-receiver with heat exchanger	Vertical cylinder type
Fan	Motor direct driven propeller type
Fan motor	Single-phase squirrel-cage induction motor
Defrost	
Heat source	Electric heater
Initiation	Timer or manual switch or air pressure switch
Termination	Sensing evaporator temperature by defrost thermistor
Refrigerant control	Thermostatic expansion valve
Capacity control	Hot gas bypass control with modulating control valve
Protection devices	Circuit breaker, Over current relay, Dual pressure switch, Oil pressure switch, Fusible safety plug, Over-heat thermistor, Compressor motor protection thermostat, Fan motor protection thermostat
Refrigerant	R12 : 6.0 (kg)/13.2 (lbs)
Lubricant	SUNISO 3GS-DI : 4.0 (ℓ)
Weight	Approx. 695 (kg)/1532 (lbs)

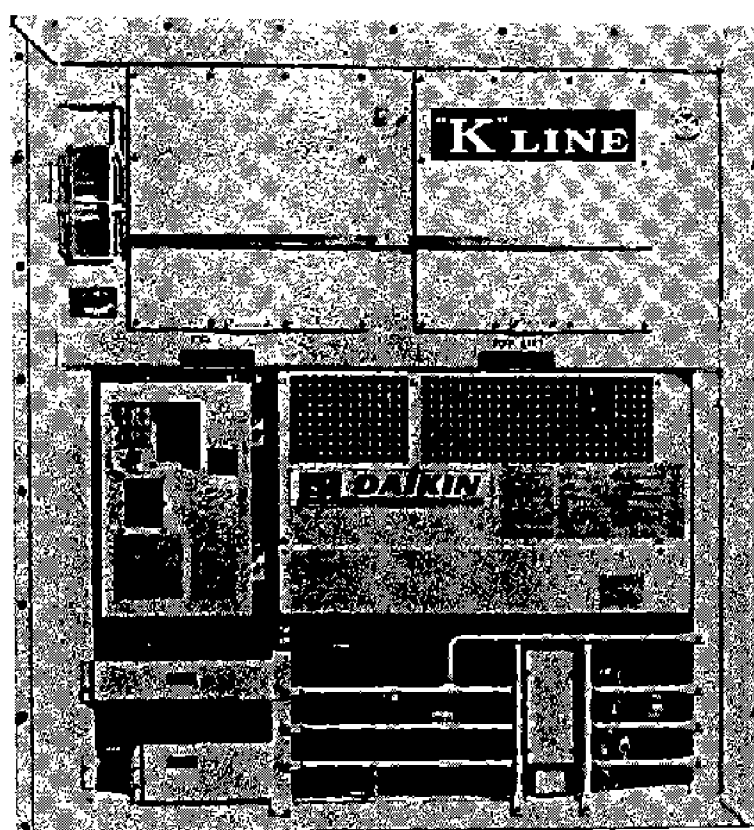

**1.2 Set values of functional parts**

Parts name	Mark	Function	Set value
Oil pressure switch WNS-C106Q1	63QL	OFF ON	1.0kg/cm <sup>2</sup> 0.5kg/cm <sup>2</sup>
Dual pressure switch DNS-D306Q	63HL	Low pressure OFF ON High pressure OFF ON	40cmHgV 0.2kg/cm <sup>2</sup> 20kg/cm <sup>2</sup> 16.5kg/cm <sup>2</sup>
High pressure control switch SNS-C130Q11	63CL	OFF ON	7kg/cm <sup>2</sup> 12.5kg/cm <sup>2</sup>
Water pressure switch LCB-BB07	63W	OFF ON	1.0kg/cm <sup>2</sup> 0.4kg/cm <sup>2</sup>
Over-heat thermistor	TH2	OFF ON	71°C (160°F) 49°C (120°F)
Defrost thermistor	TH1	OFF ON	40.6°C (105°F) 23.6°C (74.5°F)
Defrost timer		ON	4 hr (out-range) 12 hr (in-range)
Over current relay (Manual reset) GT-20-NP2S4	51C	OFF	10.0A
Circuit breaker (main circuit) MK-53	52C1	OFF	50A
Circuit breaker (control circuit) CP 31	52C2	OFF	7A
Thermal protector (fan motor)		OFF	120°C (248°F)
Thermal protector (Compressor)	49	OFF	105°C (221°F)
Air pressure switch SDS-K114	63DA	ON	25mmH <sub>2</sub> O

### 1.3 Construction

#### (1) Outside

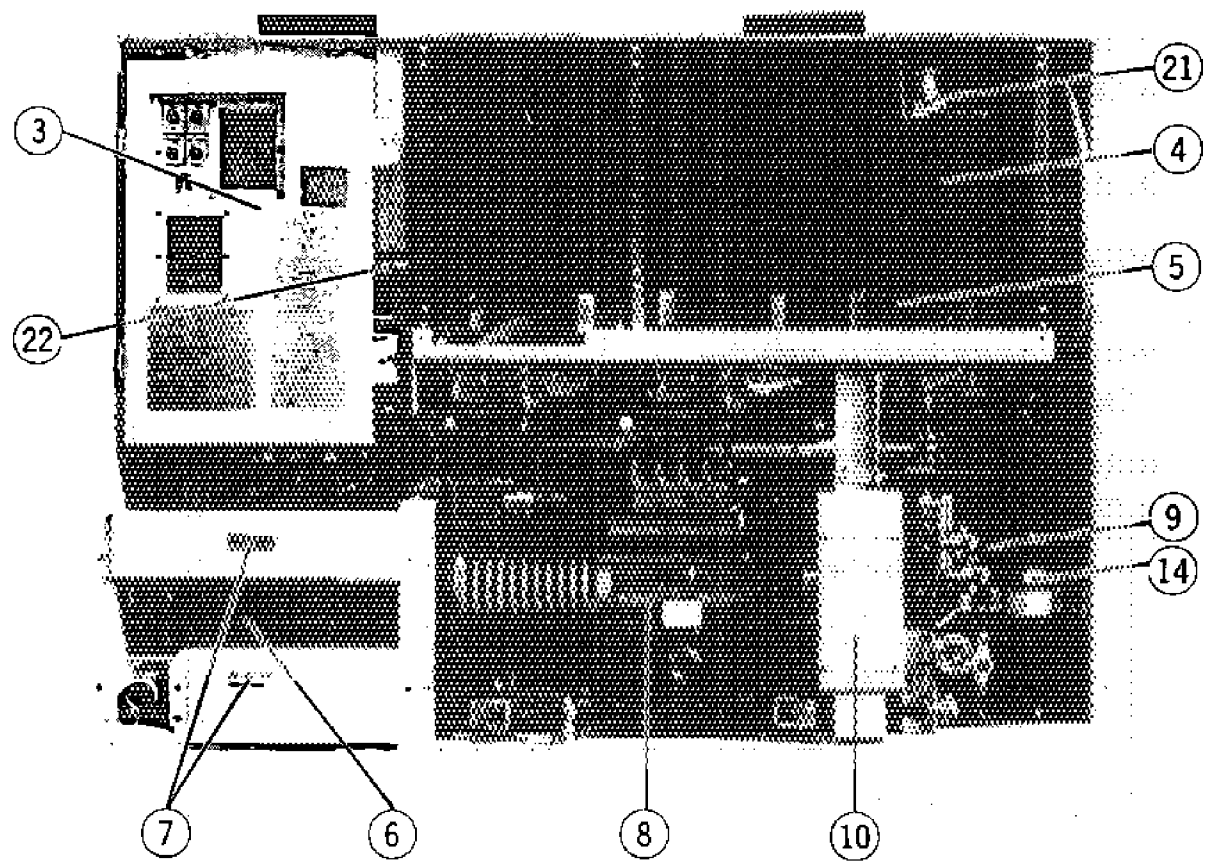
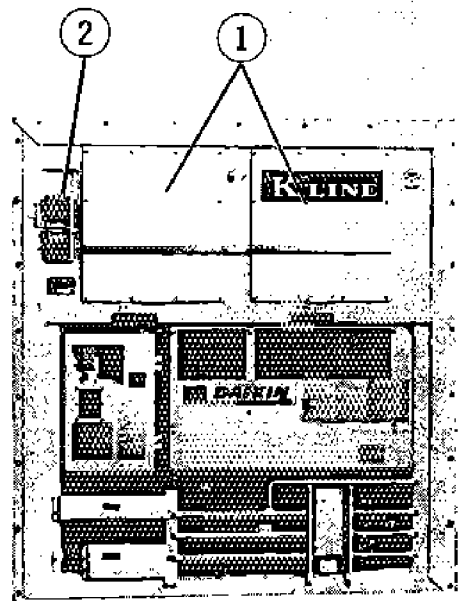

- 1 Access panel
- 2 Ventilator
- 3 Control box
- 4 Air cooled condenser
- 5 Condenser fan motor
- 6 Water cooled condenser
- 7 Cable storage
- 8 Compressor
- 9 Accumulator-receiver with heat exchanger
- 10 Pressure switch box
  - 10-1 Dual pressure switch (63HL)
  - 10-2 Oil pressure switch (63QL)
  - 10-3 High pressure control switch (63CL)
- 11 Water pressure switch (63W)
- 12 Water inlet coupling
- 13 Water outlet coupling
- 14 Dryer
- 15 Liquid/moisture indicator
- 16 Modulating control valve (20M)
- 17 Solenoid valve  
(20S1 for main line)
- 18 Solenoid valve  
(20S2 for liquid control)
- 19 Stop valve for hot gas line
- 20 Stop valve for liquid line
- 21 Expansion valve
- 22 Voltage selector switch

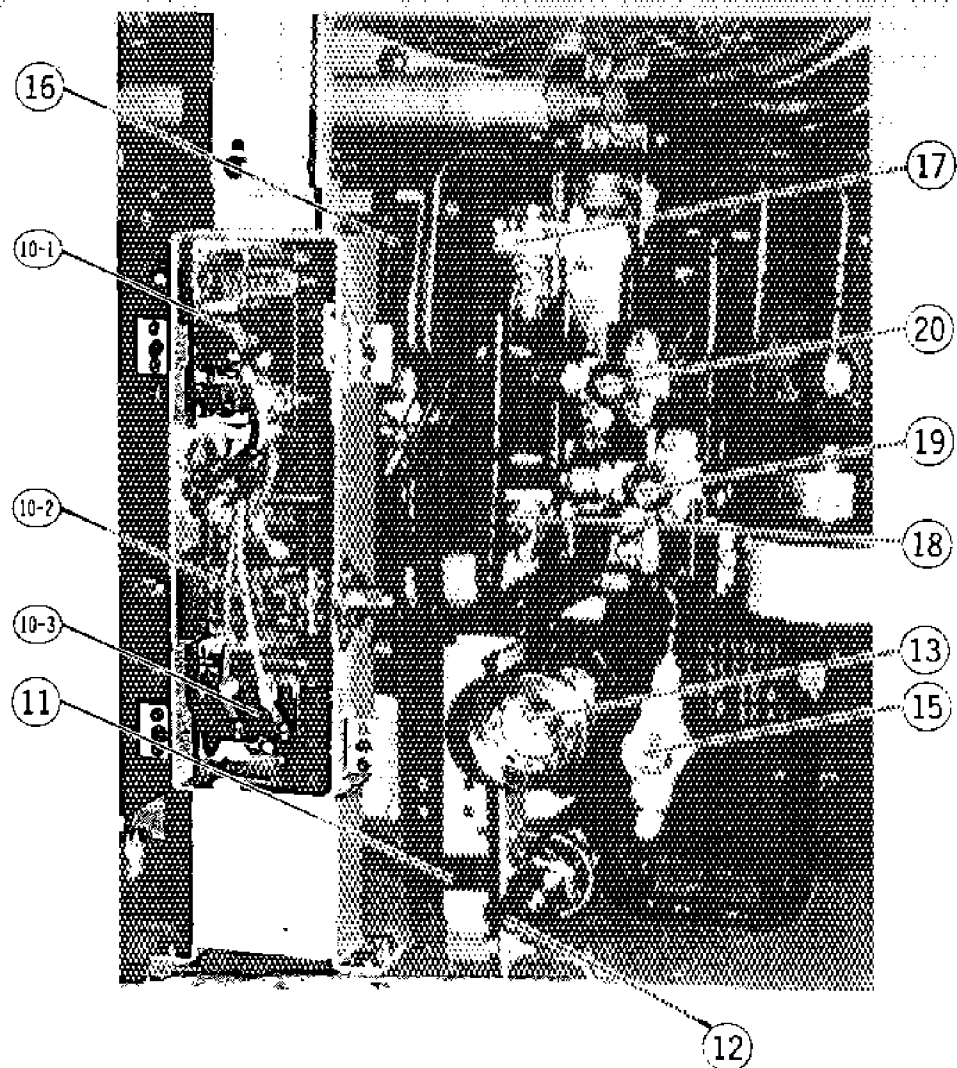



(2) Inside

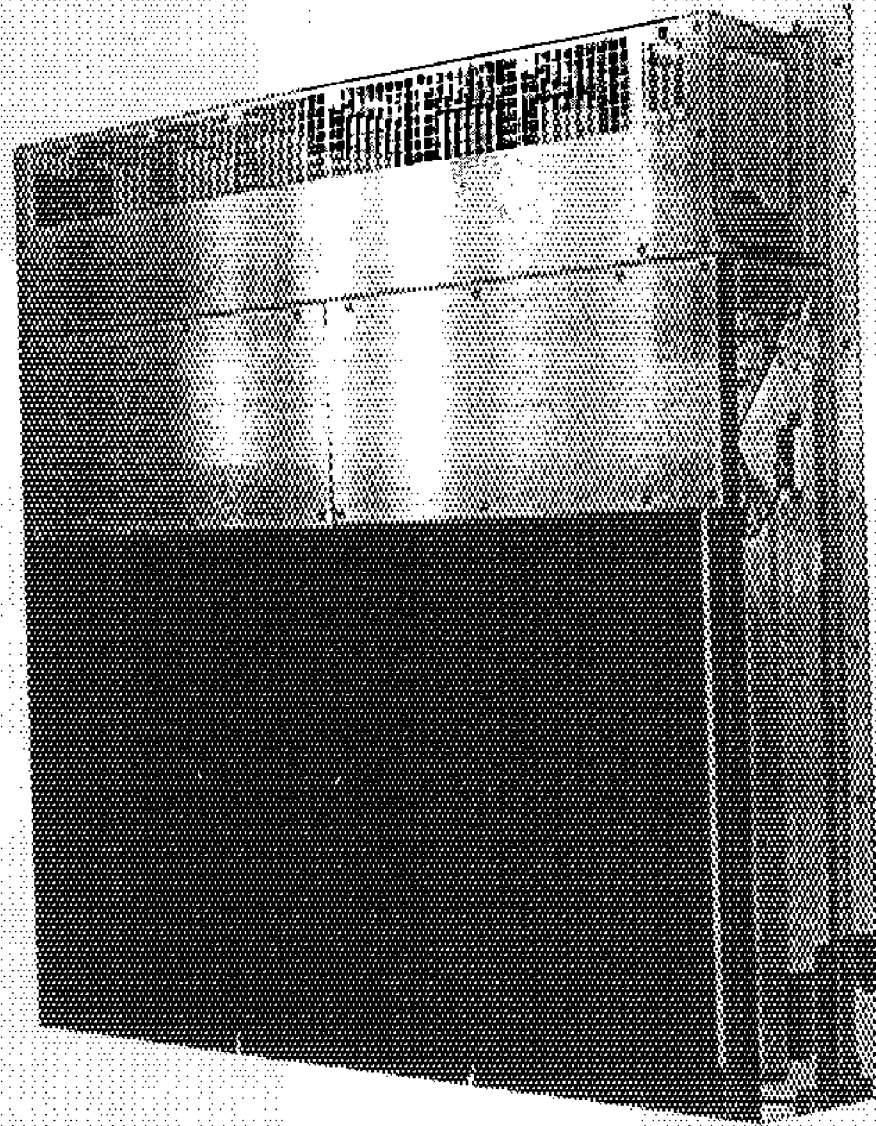

- 1 Evaporator
- 2 Evaporator fan motor
- 3 Air pressure switch
- 4 Defrost thermistor
- 5 Over-heat thermistor
- 6 Defrost heater
- 7 Drain pan heater
- 8 Junction box
- 9 Supply air sensor
- 10 Return air sensor

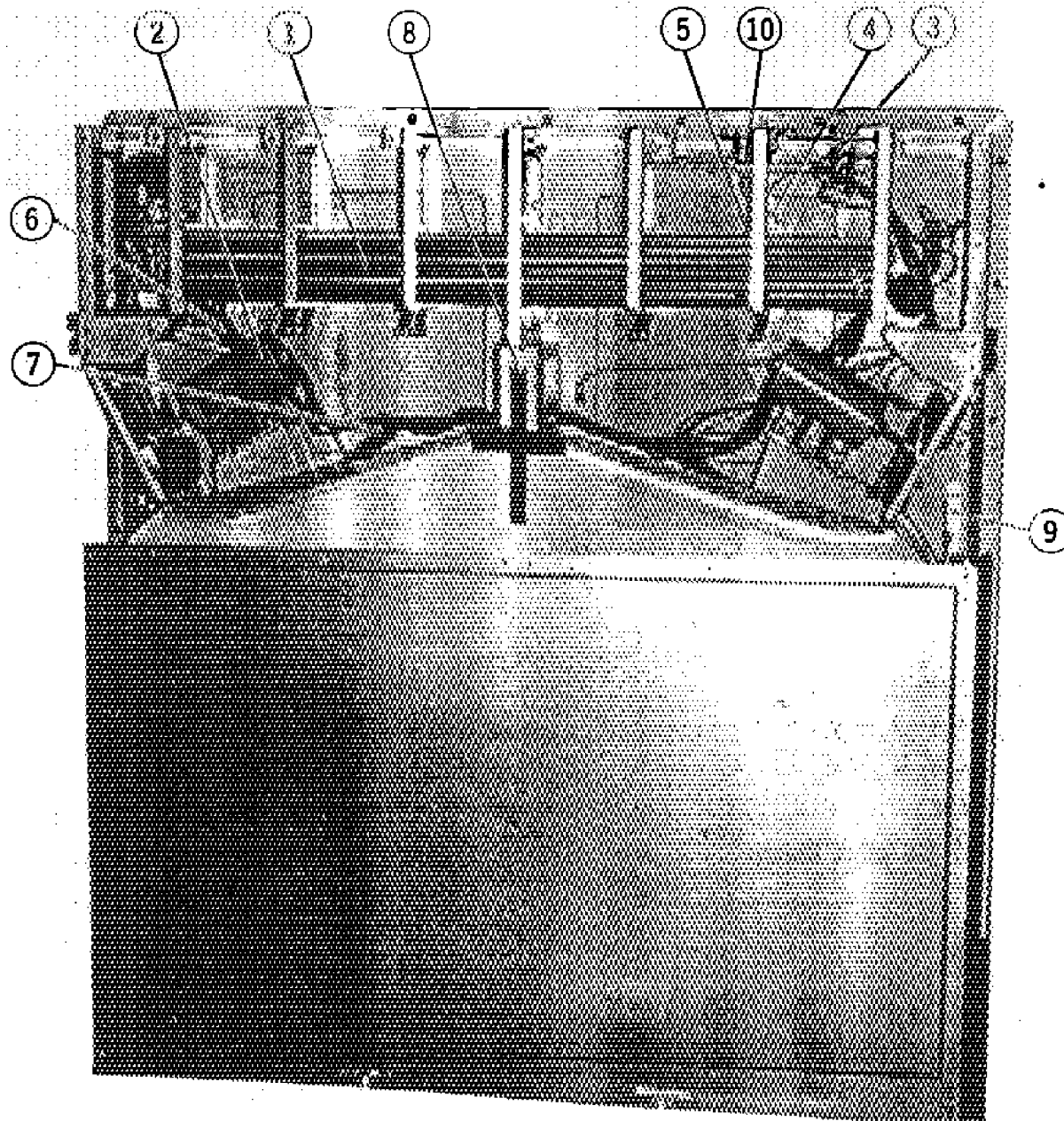

(3) Control box

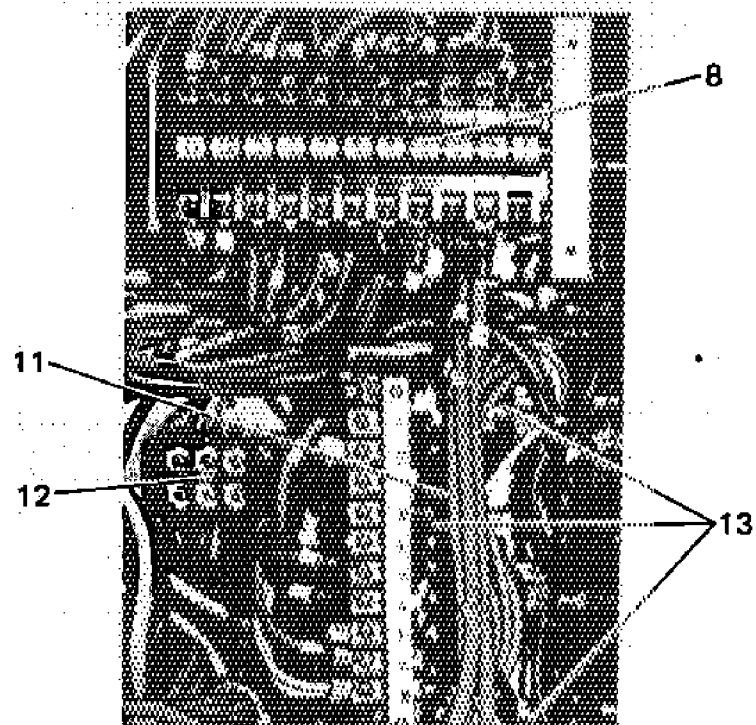
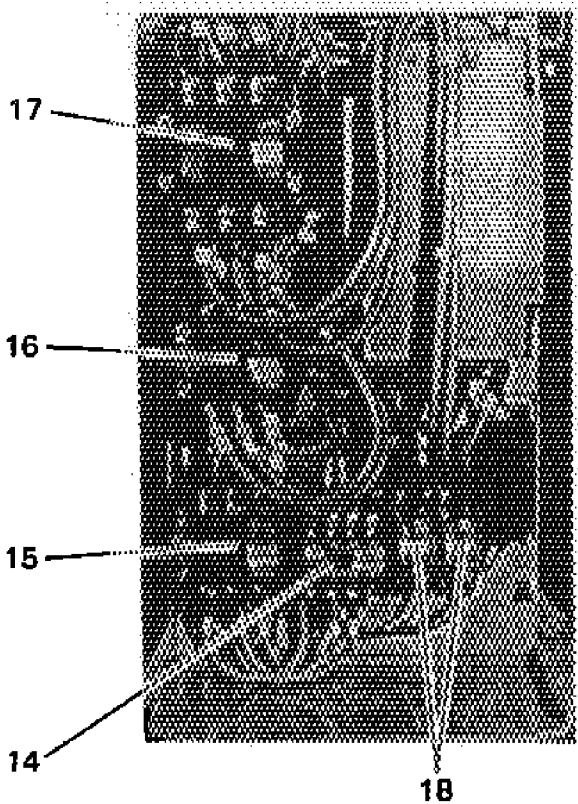
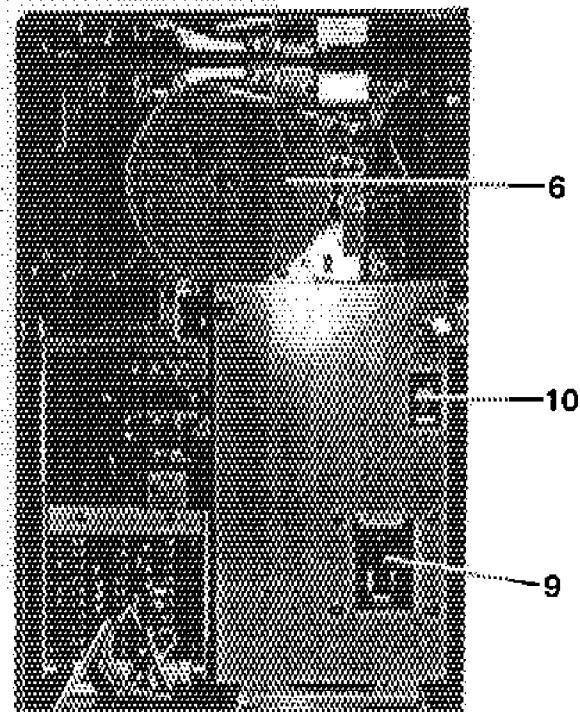
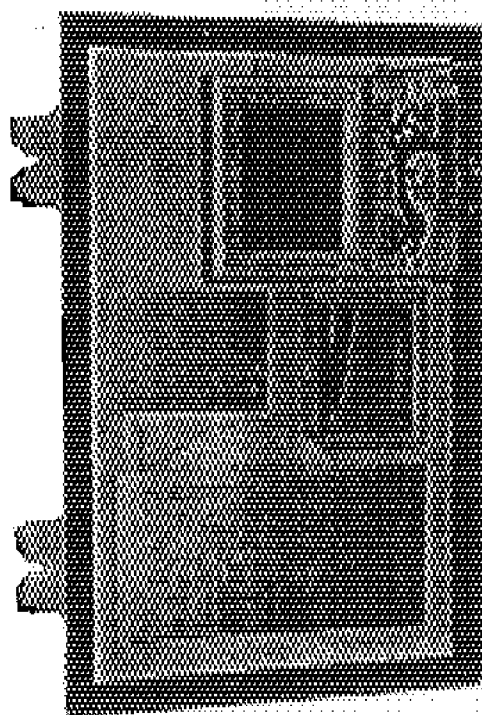
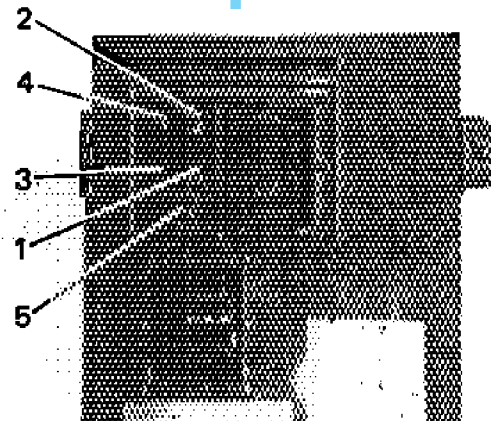
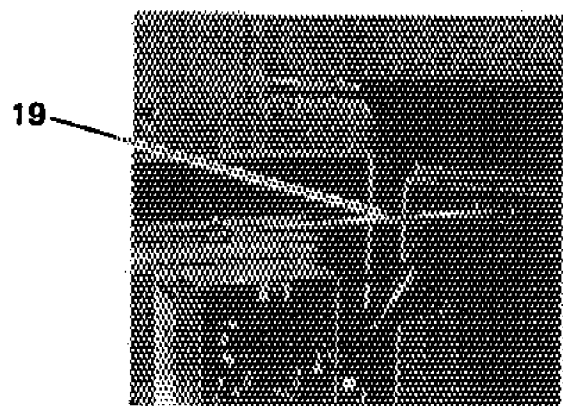

- 1 Oil pressure reset switch
- 2 Unit ON-OFF switch (3-88)
- 3 Manual defrost switch (3D)
- 4 Lamp switch (3-30L)
- 5 Cannon receptacle for pilot lamp
- 6 Recorder
- 7 Controller (23A)
- 8 Voltage selector
- 9 Circuit breaker (52C1)
- 10 Circuit breaker (52C2)

- 11 Transformer (Tr)
- 12 Over current relay (51C)
- 13 Capacitor (C1, 2, 3)
- 14 Evap. fan motor relay (88F)
- 15 Heater relay (88H1)
- 16 Heater relay (88H2)
- 17 Compressor relay (88C)
- 18 Auxiliary relay (2X4,5)
- 19 Stopper

● Be sure to use "Stopper" when operate or maintenance the components in the control box.

1.4 Piping diagram

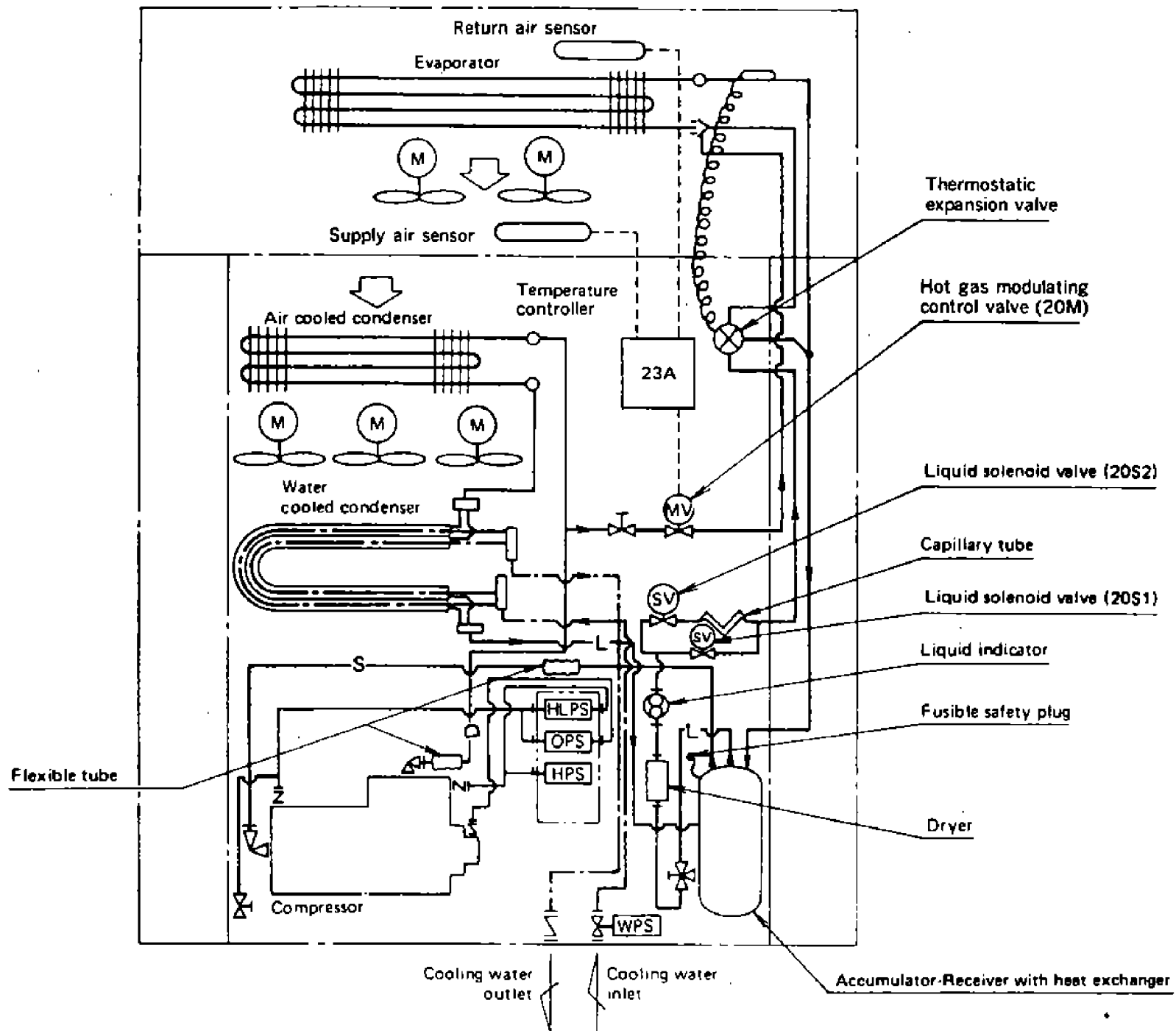

- L — LIQUID PIPE
- S — SUCTION PIPE
- D — DISCHARGE PIPE
- H — FLANGE CONNECTION
- T — FLARE CONNECTION
- — — REFRIGERANT PIPE
- — — WATER PIPE
- - - - - ELECTRIC WIRING

- HLPS(63HL) DUAL PRESSURE SWITCH
- OPS (63QL) OIL PRESSURE PROTECTION SWITCH
- WPS (63W) WATER PRESSURE SWITCH
- HPS (63CL) HIGH PRESSURE CONTROL SWITCH

## 1.5 Wiring diagram 1.5.1 Sequence wiring

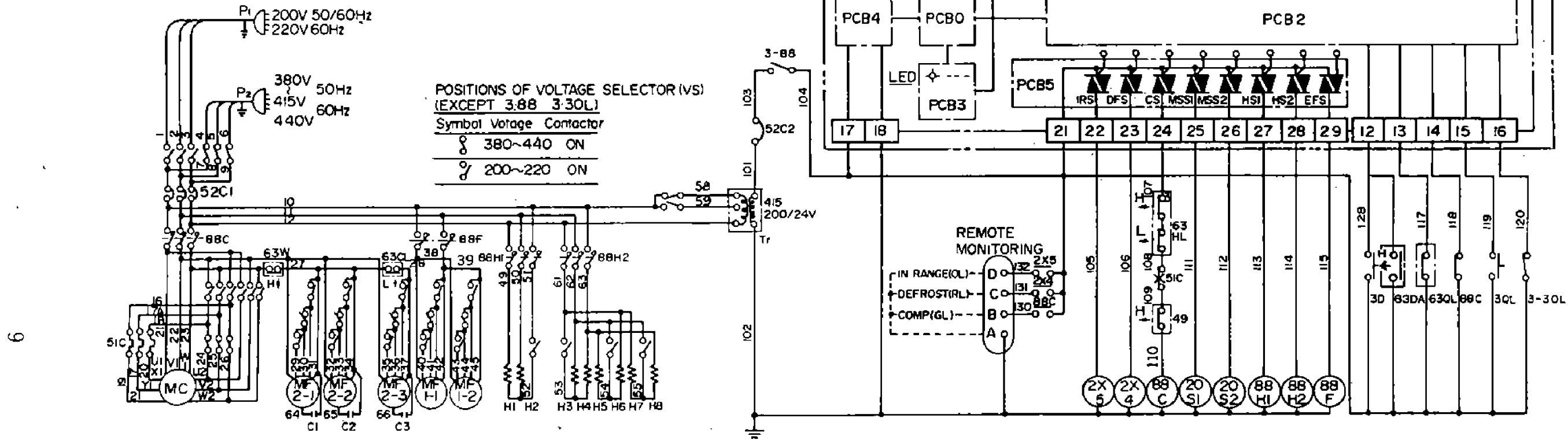

### NOTES:

- Monitoring plug connected as follows.



- A: Earth  
 B: Compressor (GL)  
 C: Defrost (RL)  
 D: In range temp. (OL)

- Broken line shows external wiring.

P	POWER PLUG	Tr	TRANSFORMER	23A	ELECTRONIC CONTROLLER
52C	CIRCUIT BREAKER	3-QL	OIL PRESSURE RESET SWITCH	PCB-0	CPU PCB
88C	MAGNETIC SWITCH FOR COMPRESSOR	3-88	ON-OFF SWITCH	PCB-1	ANALOG PCB
88F	MAGNETIC SWITCH FOR FAN MOTOR	3-30L	LAMP SWITCH	PCB-2	INPUT/OUTPUT PCB
88H	MAGNETIC SWITCH FOR HEATER	3D	MANUAL DEFROST SWITCH	PCB-3	DISPLAY PCB
2X	MAGNETIC RELAY	63W	WATER PRESSURE SWITCH	PCB-4	POWER SOURCE PCB
MC	COMPRESSOR MOTOR	63CL	HIGH PRESSURE CONTROL SWITCH	PCB-5	SOLID STATE RELAY PCB
MF1	EVAPORATOR FAN MOTOR	63HL	DUAL PRESSURE SWITCH	PCB-6	TERMINAL PCB
MF2	CONDENSER FAN MOTOR	63QL	OIL PRESSURE SWITCH	R.S	RETURN AIR SENSOR
H1~H6	EVAPORATOR COIL HEATER	51C	OVER CURRENT RELAY	S.S	SUPPLY AIR SENSOR
H7.8	DRAIN PAN HEATER	49	COMPRESSOR PROTECTOR	TH1	DEFROST THERMISTOR
20M	MODULATING VALVE	20S	SOLENOID VALVE	TH2	OVER HEAT THERMISTOR
C	CAPACITOR	63DA	DEFROST INITIATION SWITCH		

**CAUTION**  
 Insulation test shouldn't be made to control circuit (Line No. 101~)

## 1.5.2 Actual wiring

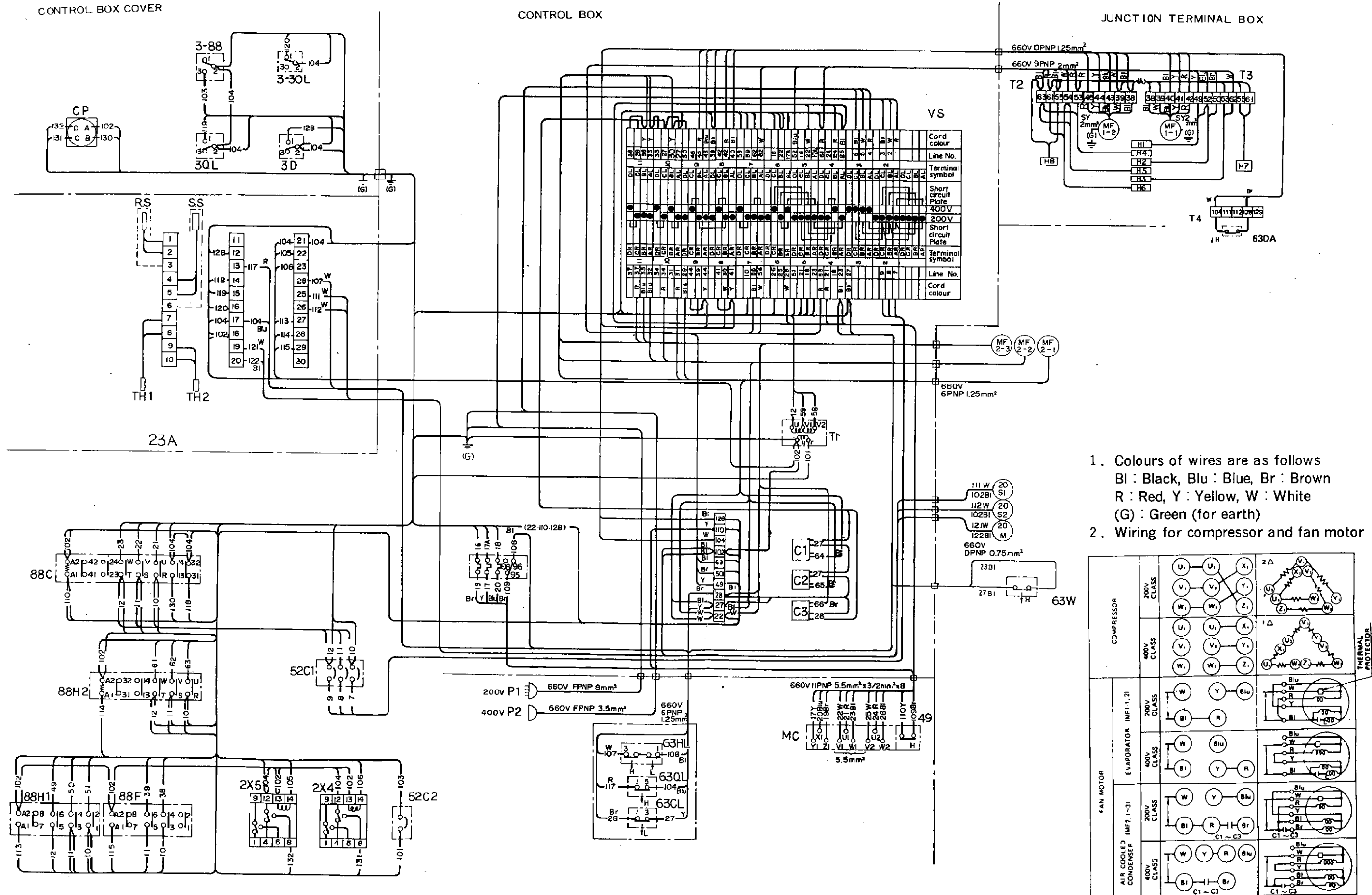

**1.5.3 How to read wiring diagram**

(1) In the wiring diagram, marks and numbers have the meanings given below.

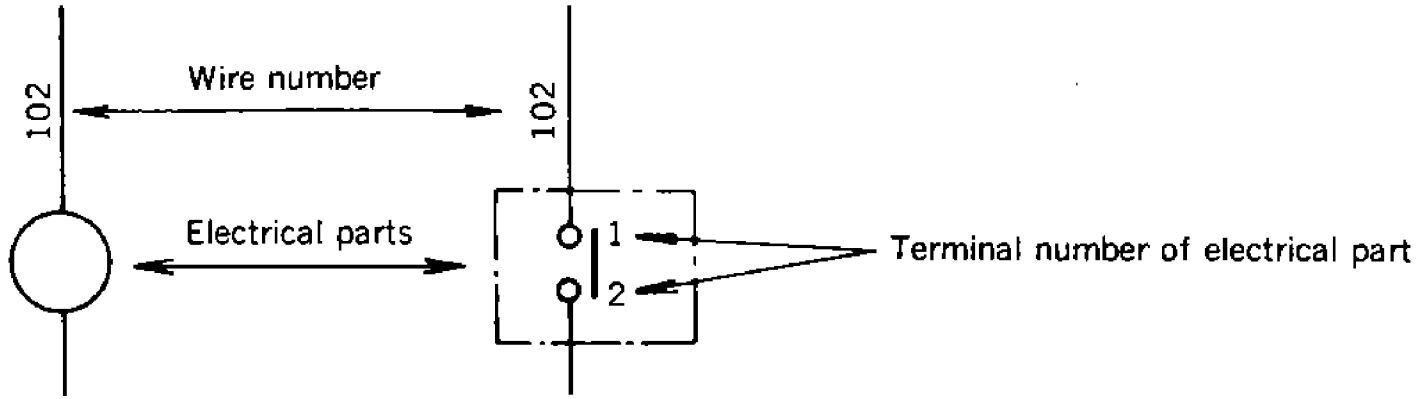

(2) Operation of contacts

- a. The wiring diagram indicates the stationary state in which the circuits are not activated.
- b. When a coil is energized (supplied with power), the associated contact changes its position.

a-contact (normal contact)		b-contact (reverse contact)	
Contact is OFF when coil is not energized	Contact is ON when coil is energized	Contact is ON when coil is not energized	Contact is OFF when coil is energized

c. Kinds of contacts

	a-contact	Operated by electromagnetic force, temperature, or pressure. ('x' denotes the reset button.)	
	b-contact		
	Time-limit a-contact	Operates when the timer counting has completed.	
	Manual contact	Contact of a snap switch. This turns on as long as the switch is kept pressed and turns off immediately when released.	
	Manual contact	Contact of a snap switch. This turns on and holds the on state once the switch is turned on.	
	Voltage selector contact (except 3-88, 3-30L)	This turns on when the selector is set to 200V class	200V class
		This turns on when the selector is set to 400V class	400V class

d .How to read the wiring diagram of the voltage selector.

In the chart, "●" denotes that the contact is on.

The following example shows the states between terminals AL2 and AR2, and between AL3 and AR2.

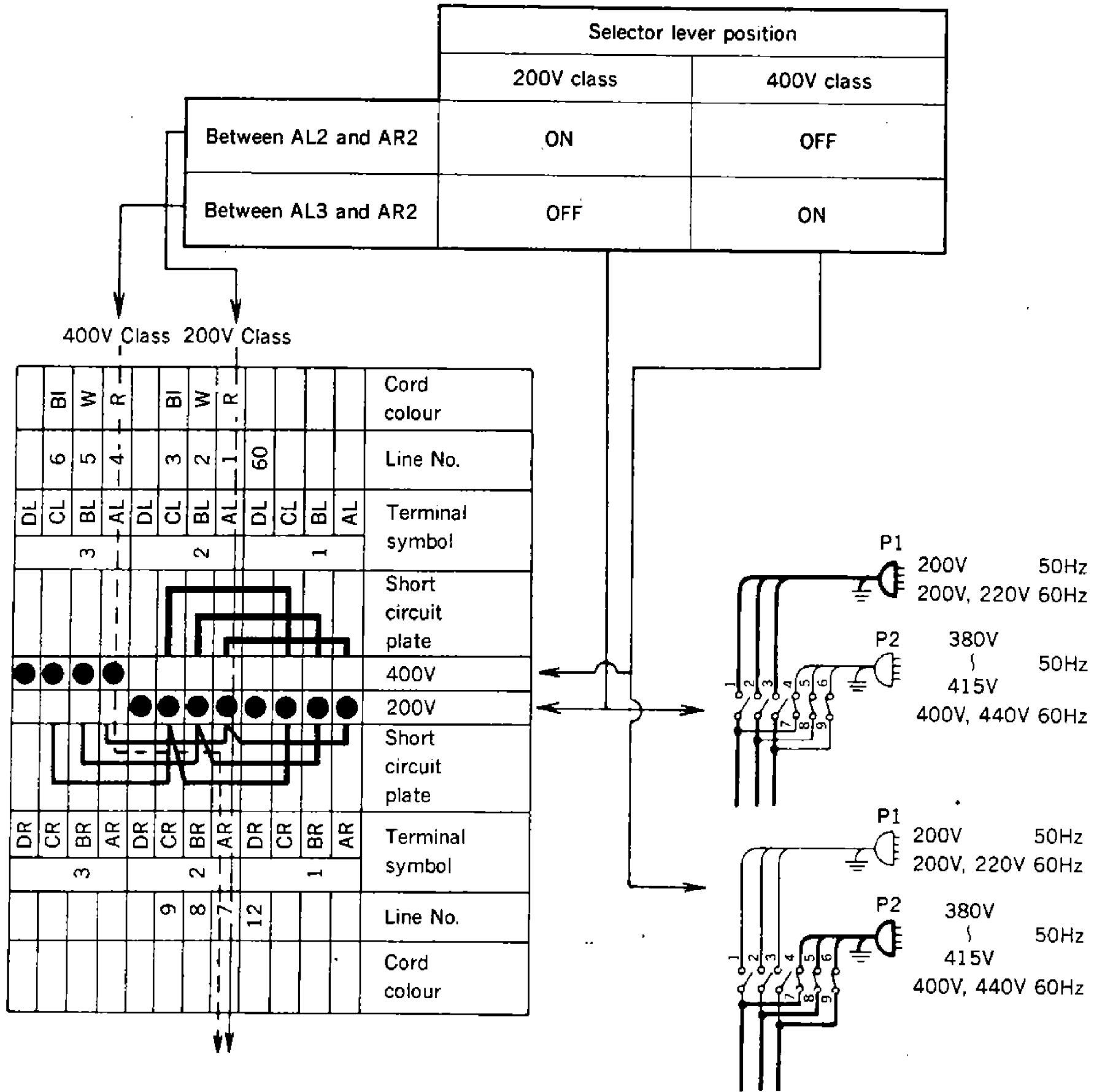

## 2. Operation

Operate the unit by the procedures given below.

- Preparation and operation
- Checking during operation
- Maintenance after operation

### 2.1 Preparation and operation

(1) Confirm that supply power is off.

Confirm that the power source, the circuit breaker and unit ON-OFF switch are turned off before checking for safety's sake.

(2) Ensuring the function of drive for the recording chart

- Ensuring life of a dry element battery

Press the switch and confirm that the needle of the remaining voltage indicator remains in the blue zone. (The meter functions only when the switch is pressed.)

- Confirming the function of quartz motor

After confirming the life of dry element battery, check through the inspection window the inside fly wheel is rotating.

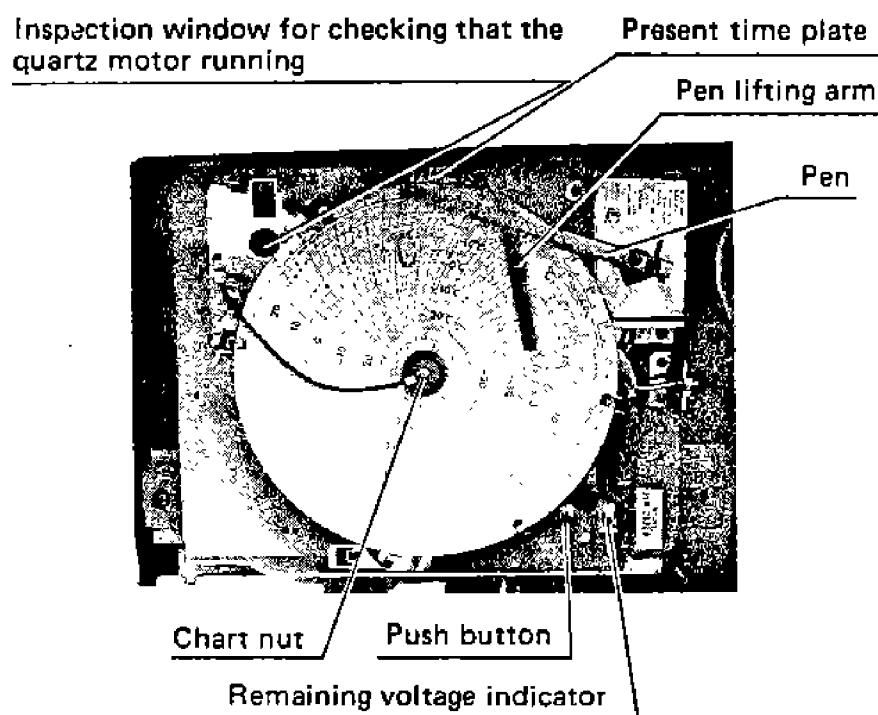

(3) Setting sheet of recording paper

- Raise the pen by the pen holder, loosen the chart nut, and place a new recording paper.
- Set the date on the paper to an arrow of present time plate, then firmly tighten the chart nut and release the pen so that the recording can be accomplished.

(4) Temperature setting procedure (The electronic controller).

- Set the indication of the set point selector on the designated temperature.



Notes 1. Do not touch the knob except when setting the temperature.

(5) Open or close the ventilator.

- Open or close the ventilator according to the cargo. (Be sure to keep it closed during transportation of frozen cargo.)

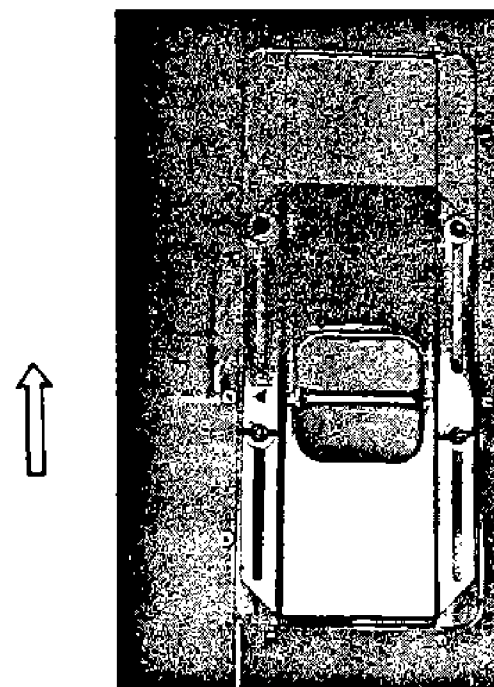

Note : If it is difficult to keep the set temperature due to excessive fresh air, adjust the opening of ventilator to close.

(6) Connect the cooling water piping.

- In the case of water-cooled operation, connect the water piping, and supply water through it.

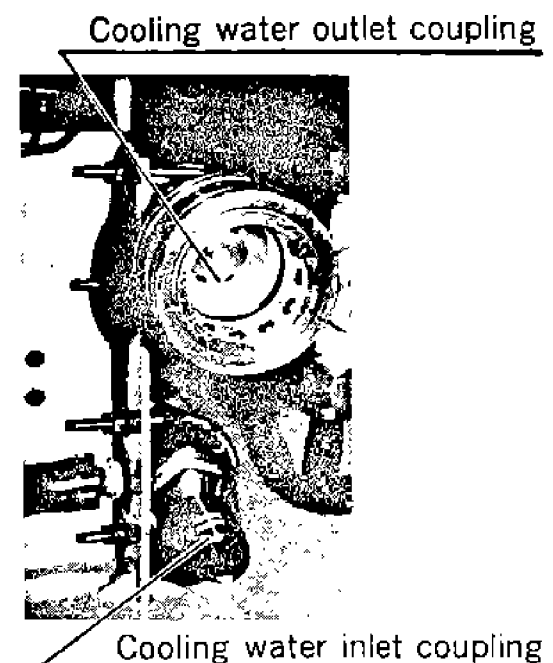



● Connecting method

1. Connect the cooling water inlet coupling.
2. Connect the cooling water outlet coupling.

● Disconnecting method.

1. Disconnect the cooling water outlet coupling.
2. Disconnect the cooling water inlet coupling.

When the cooling water couplings are connected, insert the coupling on the ship side into the coupling on the unit side until a "click" is heard.

When disconnecting them, pull the coupling on the ship side toward you while pushing the A part of the female coupling in the direction pointed by an arrow mark.

Both at connecting and disconnecting, be careful for splash of cooling water.

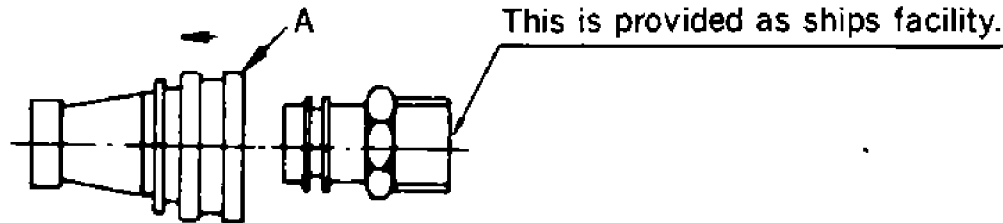

- (13) The controller outputs after 1~3 seconds delay, and the unit starts operation.
- (14) Close the cover of the control box.  
If it is loose, water will leak. Check around the packing and tighten the cover securely.

Note: If the unit stops in about 2 minutes after starting, the oil pressure switch in many cases has been activated. At this time, electronic controller ALARM (OIL PRESS.) lights.  
At this time, turn on the oil pressure reset switch (3-QL). The operation is automatically started after 2 minutes. (If the switch is turned on within 2 minutes after the oil pressure switch is energized, the ALARM lamp flickers.) If the unit stops again, repeat the above procedures.

- (7) Check that all refrigerant stop valves are opened.
- (8) Set the voltage selector according to the supply voltage.

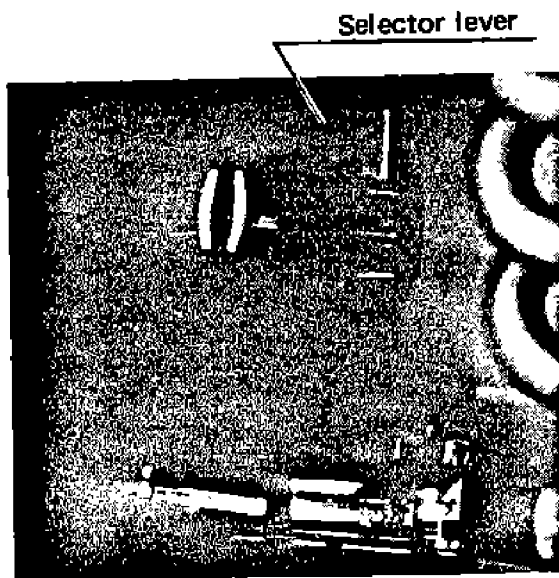

- (9) Plug in the power source which supplies the proper voltage and fasten the plug firmly.

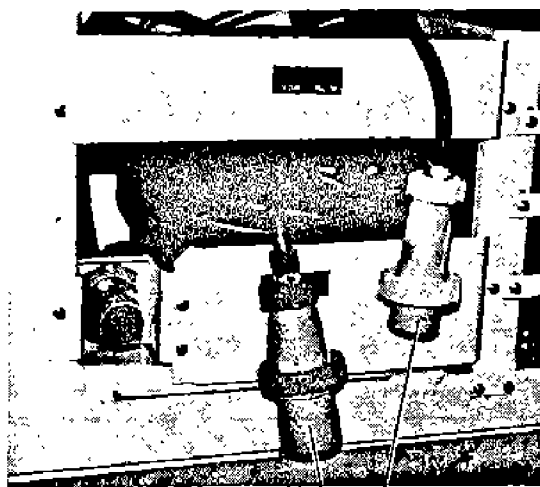

Power plug (200V class)

Power plug (400V class)

- (10) Turn on the power switch of the facility (outside the unit).
- (11) Turn ON the circuit breakers.
- (12) Turn ON the operation switch provided at the front of the control box.

## 2.2 Checking during operation

Checking items (precautions)	Method of check
1. Check if unusual noise and vibration is produced from compressor, fan and piping etc.	Visual, sensuous and touching.
2. Check to ensure oil pressure protection switch functions, and the unit does not stop.	Visual (Controller alarm display)
3. Check suction and discharge pressures of the compressor. (For installation of a gauge, refer to "Section 8")	Compare observed data with standard ones.
4. Check for proper oil level of compressor. Check to see the oil is clean. (Oil level may fall for a while after starting, but it rises gradually.)	Visual Oil level should be approx. $\frac{1}{4}$ to $\frac{3}{4}$ of its full scale.
5. Check to see if refrigerant is sufficient. (The refrigerant bubbles immediately after starting, but this does not mean that refrigerant is lacking.	Shortage of refrigerant is indicated by bubbles in the moisture indicator.
6. Check if any moisture is present in refrigerant circuit. (The color of moisture indicator may turn to yellow if it has been exposed to gaseous refrigerant for a long time, but this is no indication of trouble.)	Visual The moisture indicator should normally appear green. Yellow color is a sign of trouble.
7. Check if the recorder operates according to the inside temperature.	Visual
8. Check operating conditions with the pilot lamps (LED).	Visual

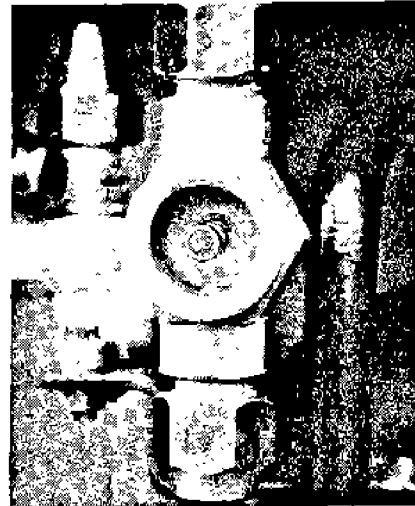
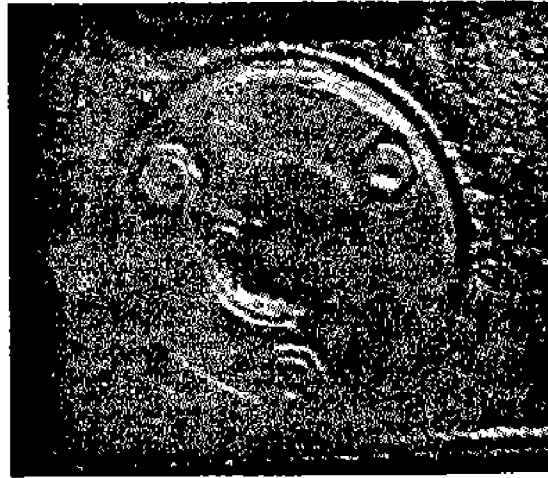

## 2.3 Maintenance after operation

- (1) Stopping  
To stop the unit, perform defrosting operation with the manual defrost switch and immediately turn off the unit ON-OFF switch after the compressor has stopped, (stop the unit with "pump-down" state.) After pump down, turn off the circuit breakers.
- (2) Stowing the power cable  
Turn the plug's opening downward so that sea and rain water cannot enter the plug when stowing it.
- (3) Close the cover of the control box tightly.
- (4) After water-cooled operation  
Remove the water piping.

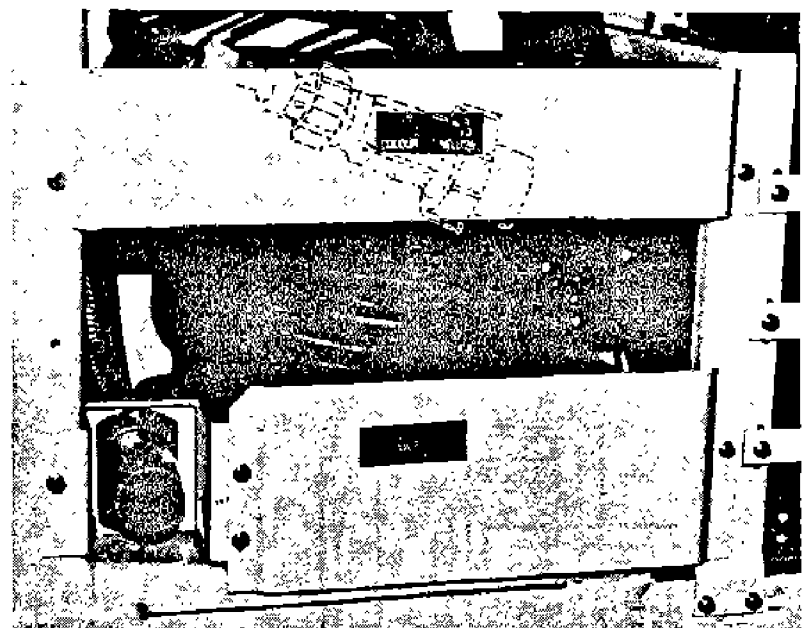

### 3. Operating modes and circuits

#### 3.1 Voltage selection system (switching over 200V and 400V class)

(1) This unit is adaptable to either of two supply voltages (dual rated voltage). Set the voltage selector (multicontact cam switch) according to the supply voltage by hand. The voltage selector changes wiring of the motors, electric heaters, and the transformer of the control circuits to supply the relevant voltage. For example, the internal wiring of the compressor is changed as follows.

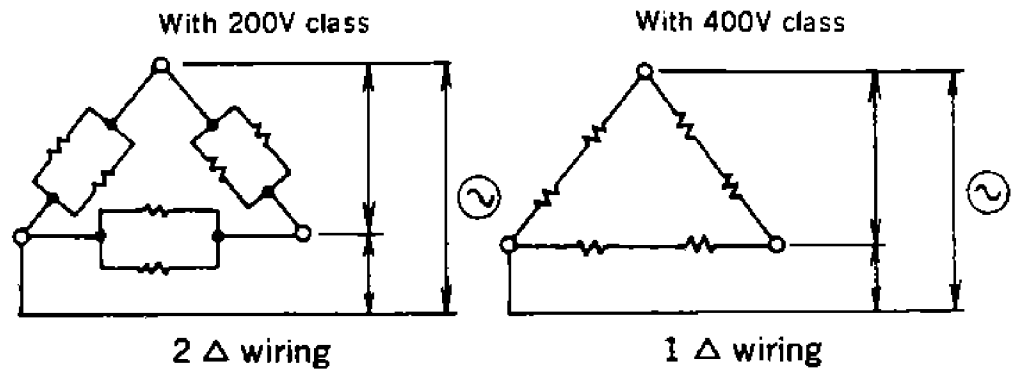

(2) Circuitry

- With 200V class (Set the selector lever to "200V CLASS".)  
The contacts marked "200" in the sequence chart (except 3-88 and 3-30L) are turned on.

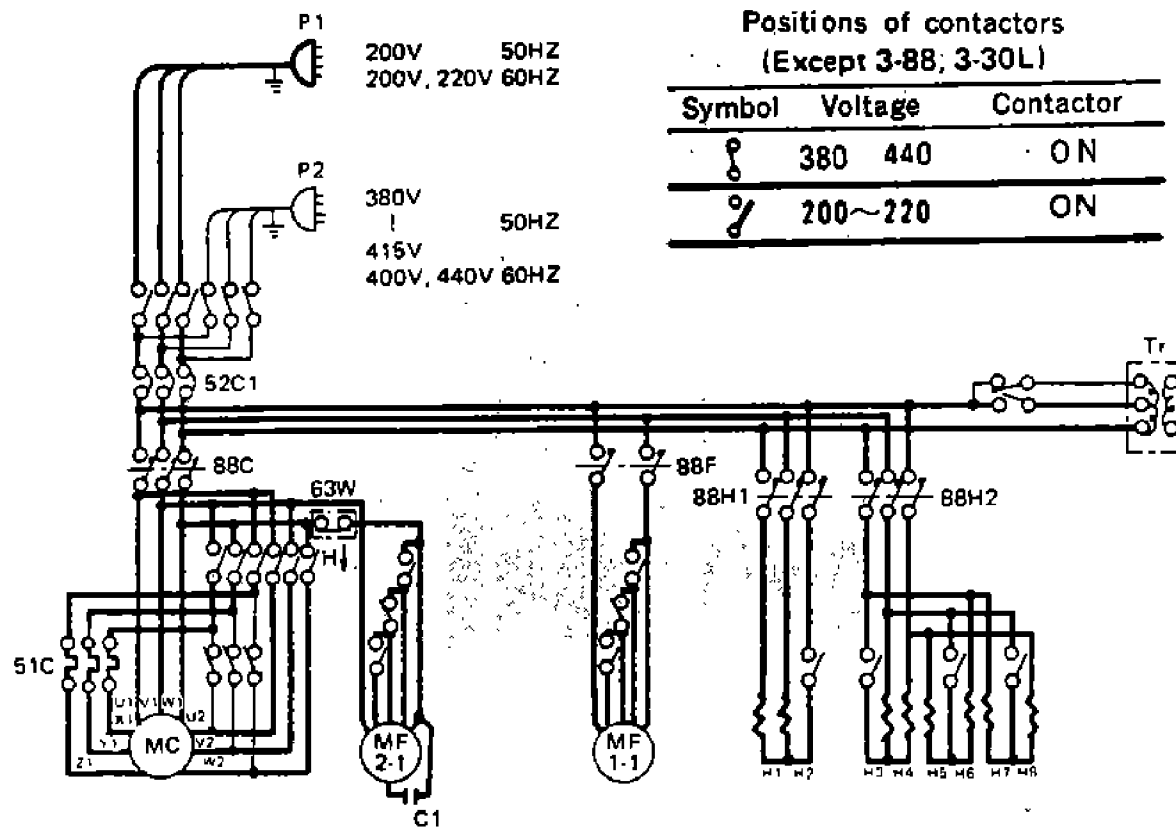

Positions of contactors  
(Except 3-88; 3-30L)

Symbol	Voltage	Contactors
	380 440	ON
	200~220	ON

Note: MF2-2, 2-3, and MF1-2 are not shown.

- With 400V class (Set the selector lever to "400V CLASS".)

The contacts marked "400" in the sequence diagram are turned on and the circuits for 400V class will be set up.

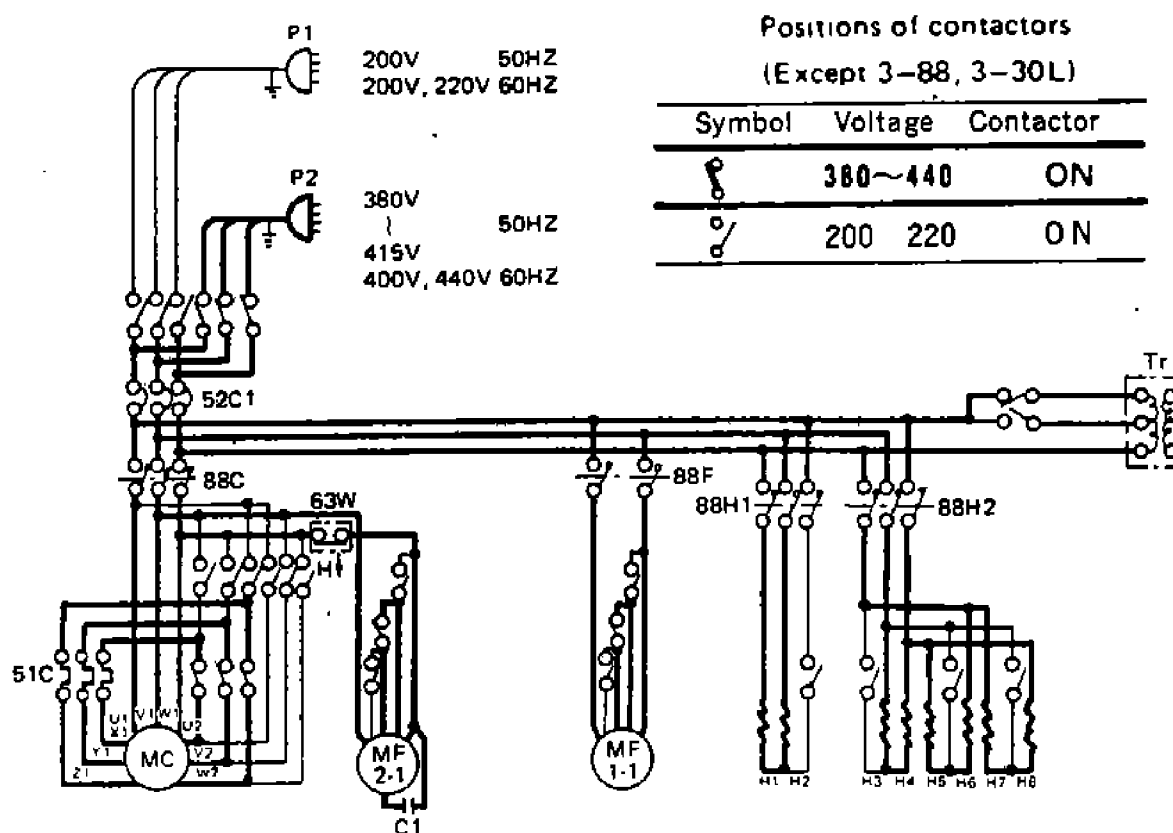

Positions of contactors  
(Except 3-88, 3-30L)

Symbol	Voltage	Contactors
	380~440	ON
	200 220	ON

Note: MF2-2, 2-3, and MF1-2 are not shown.

### 3.2 Frozen operation

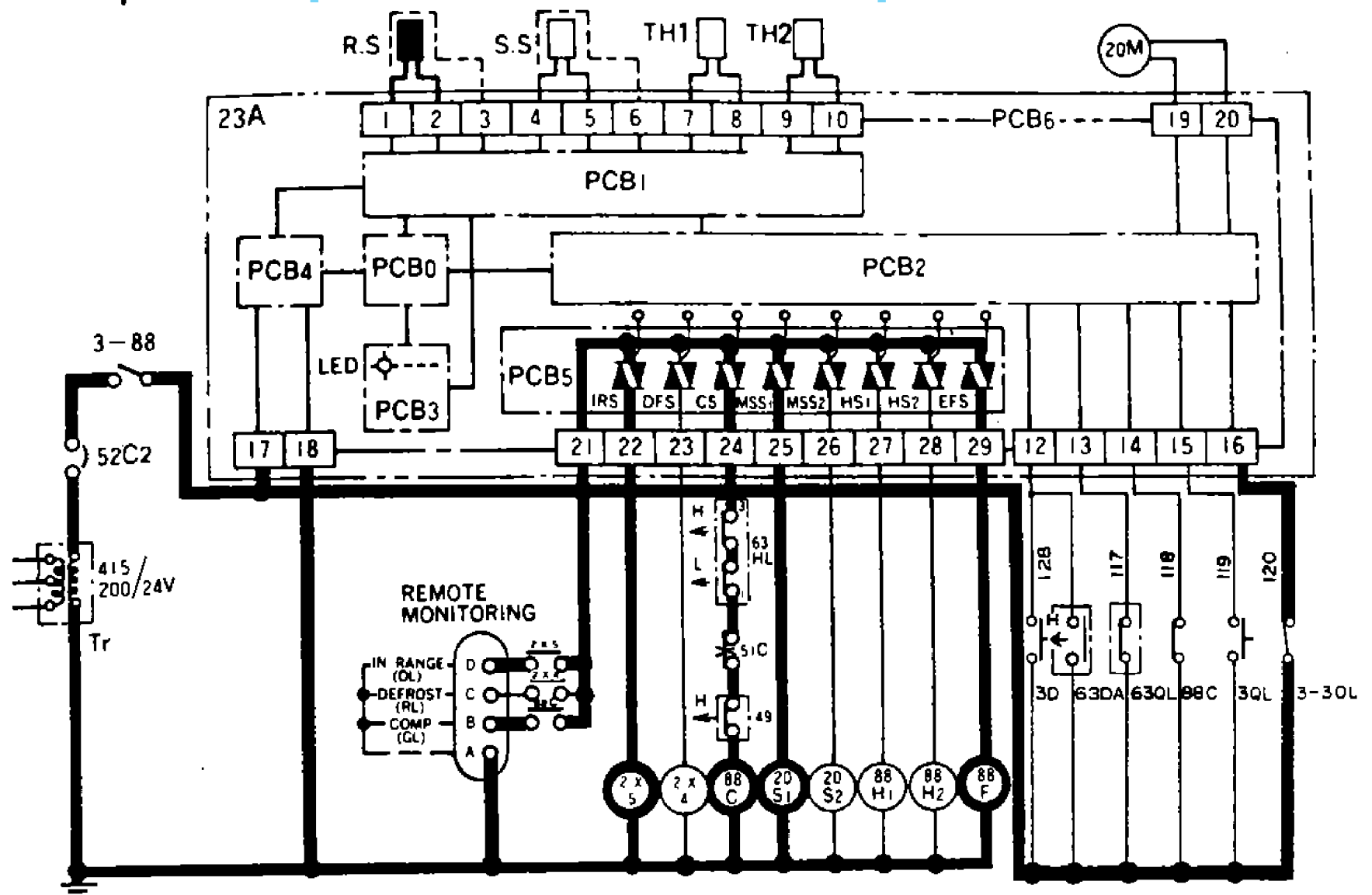

(1) Switching over frozen and chilled modes

One of the modes will be automatically selected according to the setting of the set point selector.

- When the setting is above  $-5^{\circ}\text{C}$  : chilled mode
- When the setting is less  $-5^{\circ}\text{C}$  : frozen mode

Note that in the frozen mode is operated without capacity control.

(2) During frozen mode, the compressor will be automatically turned on and off, sensing return air temperature to the evaporator.

- a. Turn on 3-88 (unit ON-OFF switch).
- b. As relay EFS in 23A is turned on, 88F is energized to start MF 1-1 and 1-2 (evaporator fan motors).
- c. As relay MSS1 in 23 A is turned on, solenoid valve 20S1 is opened. (MSS2 is turned off and 20S2 is closed.)
- d. When 20S1 is open, refrigerant flows and low pressure rises. LP of 63HL (dual pressure switch) is turned on.
- e. With LP on, 88C (compressor relay) gets energized. MC (compressor) and MF2-1, 2 and 3 (air-cooled condenser fan motors) will start and GL (green lamp) will light up. --- The unit enters in the normal operation and inside temperature begins to fall. ---
- f. When return air temperature to the evaporator falls to  $1.0^{\circ}\text{C}$  above the preset temperature, (preset temperature plus  $1.0^{\circ}\text{C}$ ), IRS (23A) is turned on and OL (orange lamp indicates that inside temperature is within range) lights up.
- g. When the temperature falls lower than the preset temperature, MSS1 (23A) is turned off 20S1 closes, and "pump down" starts.
- h. When the low pressure falls down to  $40\text{cmHgV}$ , LP of 63HL is turned off; 88C becomes unenergized; MC,

MF2-1, 2, and 3, etc. stop; and frozen operation stops.

- i. If 20S1 is closed but still MC does not stop "pump down," and the inside temperature drops  $2^{\circ}\text{C}$  below the preset temperature, CS, IRS (23A) are turned off to deenergize 88C. Then, the compressor is stopped and OL goes out.
  - j. When the temperature rises to the preset temperature minus  $1.0^{\circ}\text{C}$ , IRS is turned on and OL lights up.
  - k. When the temperature rises to the temperature setting plus  $1^{\circ}\text{C}$ , CS and MSS1 are turned on and frozen operation starts through the process of c→d→e described previously. The compressor is normally operated on and off repeatedly by operation of "g, h" → "k"
- (ON/OFF of MSS1 → OPEN/CLOSE of 20S1)
- l. If the temperature rises further up to the preset temperature plus  $2^{\circ}\text{C}$ , IRS is turned off and OL will go out.

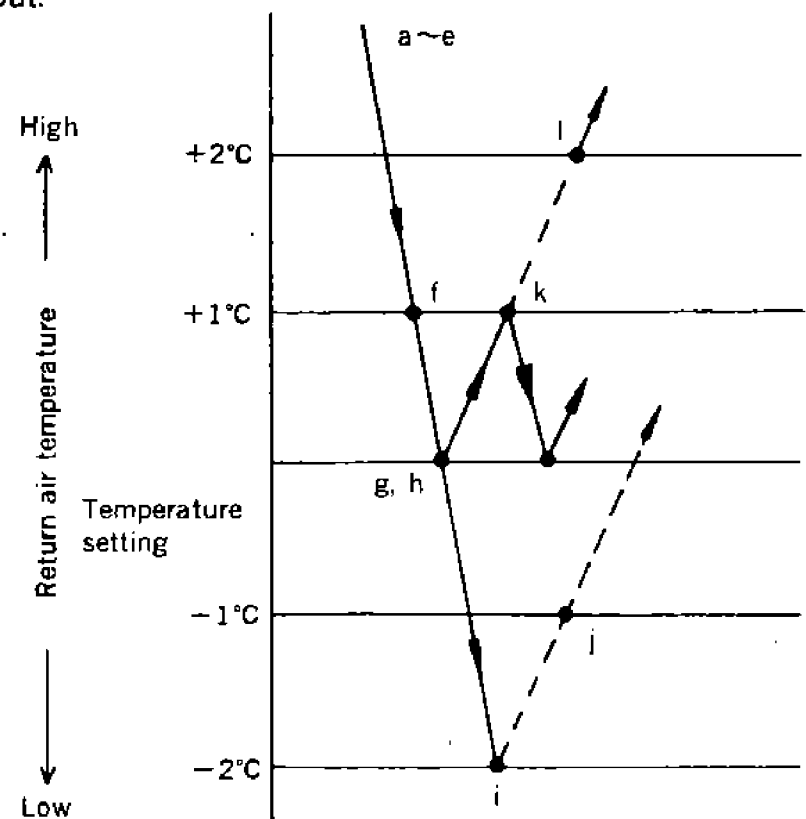

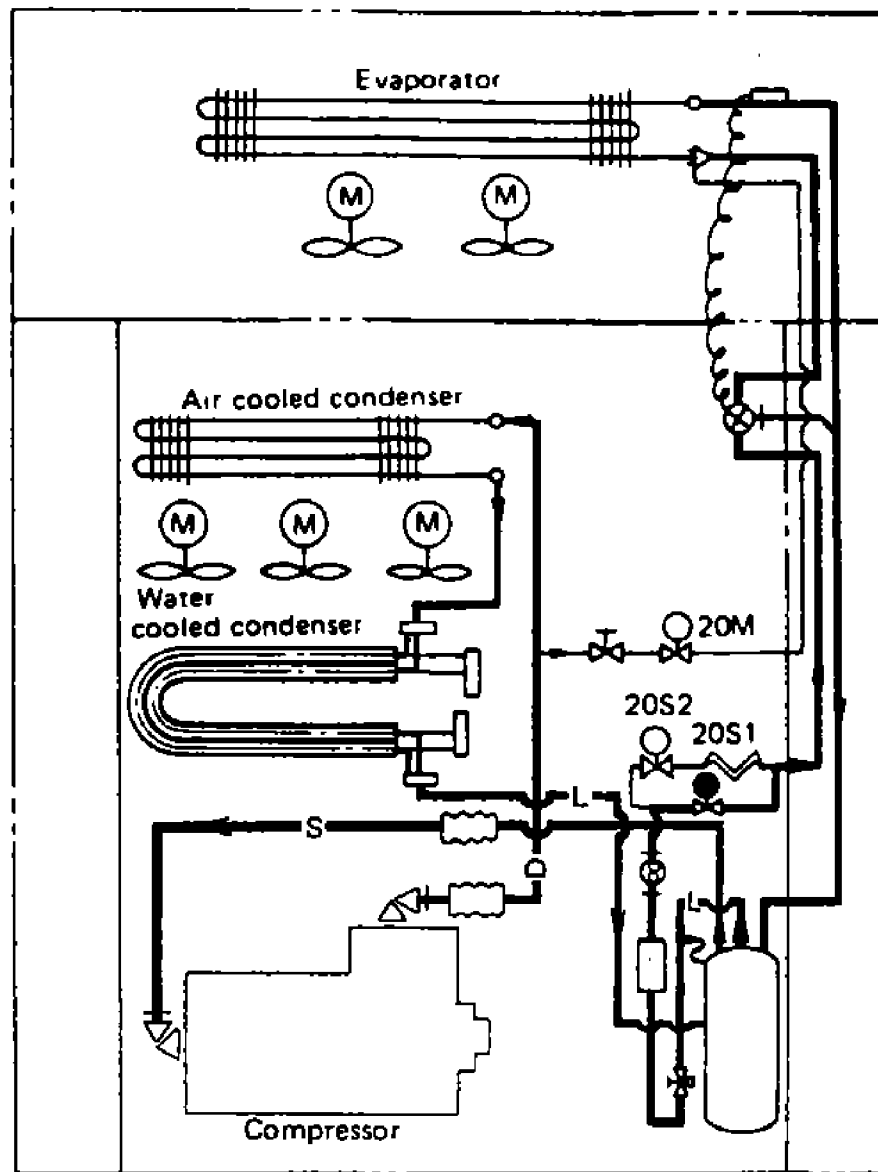

Flow of refrigerant during frozen operation

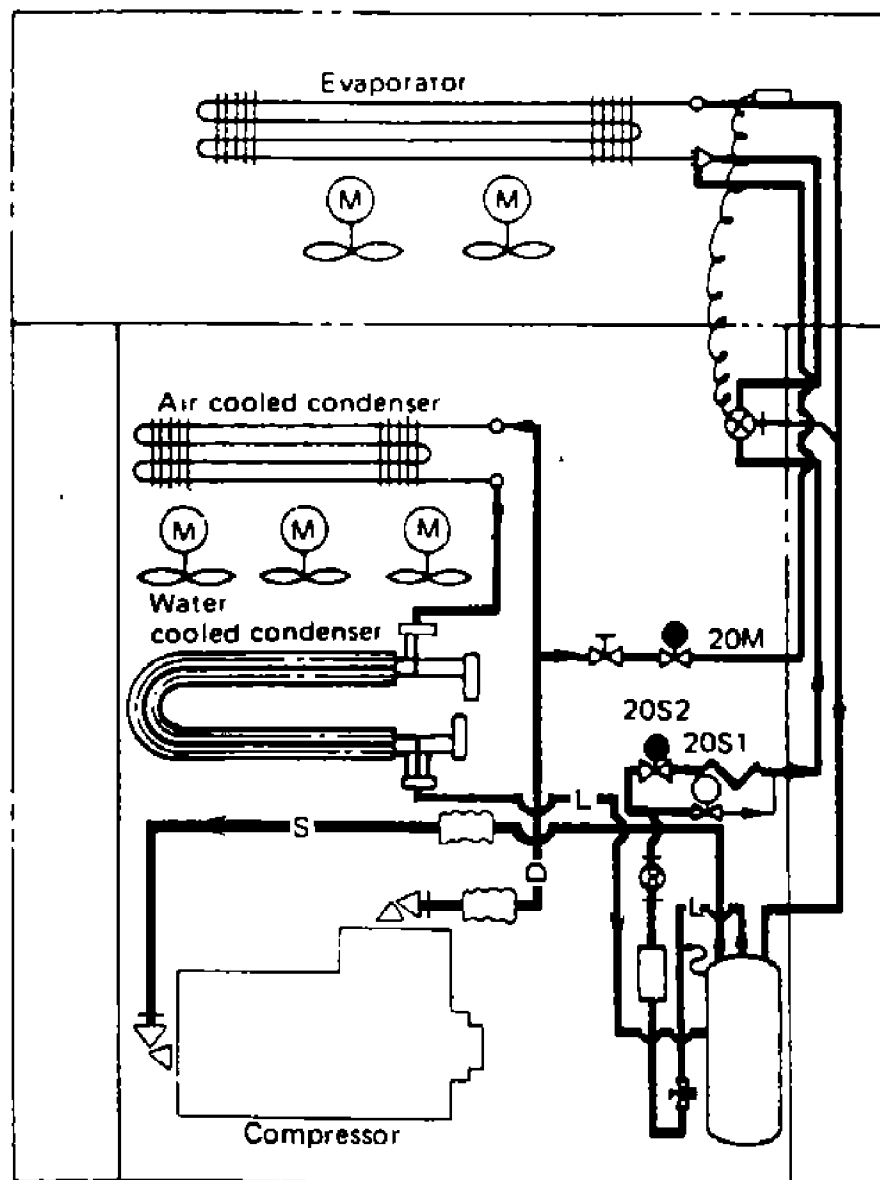

Flow of refrigerant during chilled operation

### 3.3 Chilled operation – capacity control

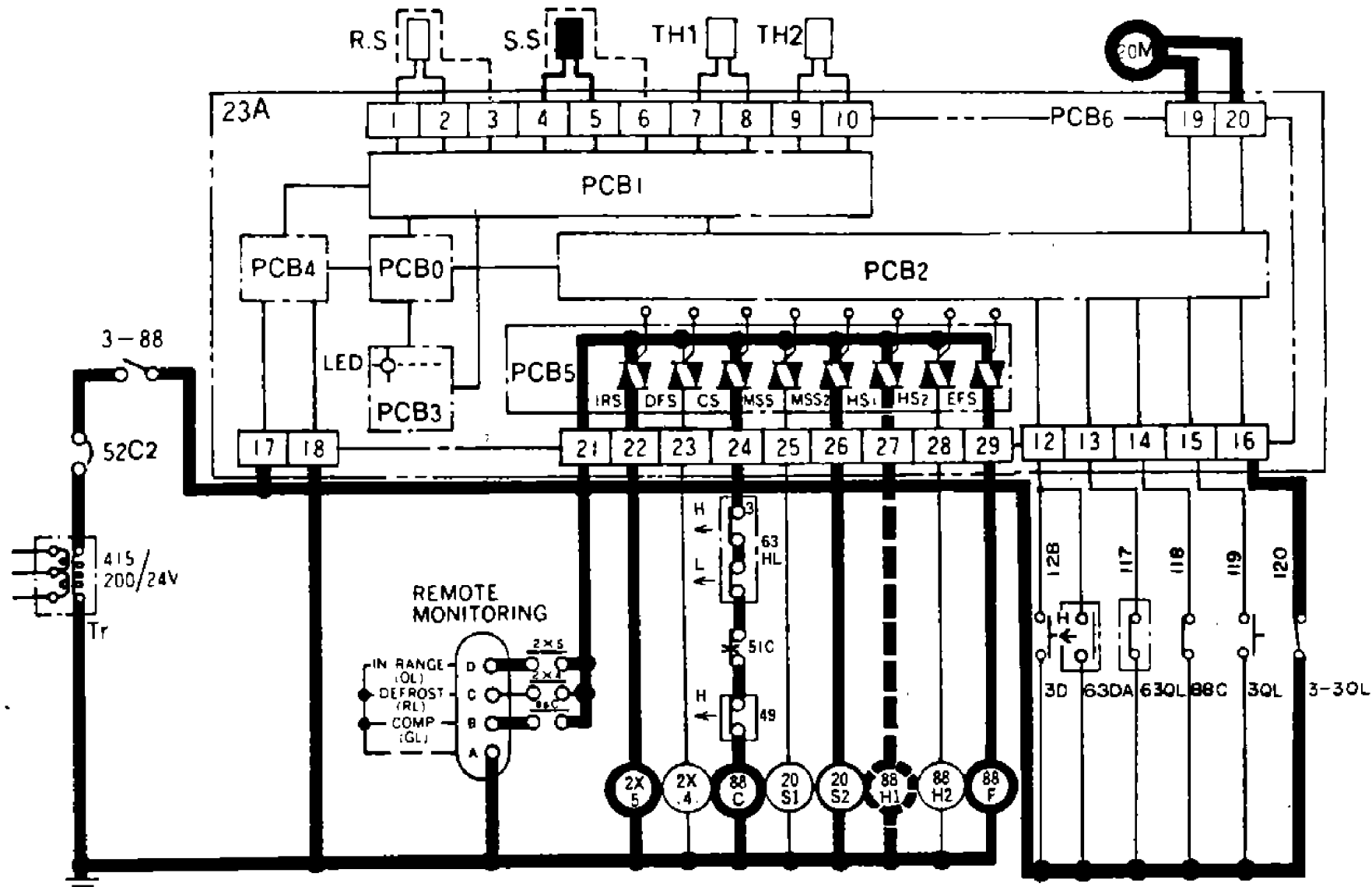

- (1) Chilled operation is performed when the preset temperature is  $-5.0^{\circ}\text{C}$  or higher, and the circuit of the chilled mode is made by 23A automatically.
- (2) Chilled operation is controlled sensing supply air temperature from the evaporator ; i.e., the modulating control valve (20M) controls the amount of hot gas to be bypassed continuously while a capillary tube controls the liquid refrigerant.
  - a .The operation is the same with that (step "a"~"e") of the frozen mode while supply air temperature falls to the preset temperature plus  $1.0^{\circ}\text{C}$  from the pull down period.
  - b .When the supply air temperature reaches the preset temperature plus  $1.0^{\circ}\text{C}$ , IRS is turned on (OL lights), MSS1 is turned off, 20S1 closes; and, the capillary tube controls the liquid refrigerant. (20S1 remains closed after that.) The voltage is simultaneously applied to 20M to open it and let the hot gas flow.
  - c .When the hot gas start flowing, temperature rises temporarily which may cause IRS to be turned off in some cases. However, the operation will enter in stable state after repeating such conditions several times.
  - d .After the temperature has been reached the preset temperature, it takes about an hour for the unit to reach a steady state. (the opening of 20M is nearly fixed; i.e., the flow of bypassing hot gas is nearly constant.) (This interval varies somewhat with the preset and ambient temperatures.) During this time, the valve changes its openings to control the flow of hot gas until the supply air temperature becomes stable.
  - e . Depending on operating conditions (such as when the difference between the ambient and preset temperature is small), IRS is turned off and lamp OL goes out if the supply air temperature becomes  $-2^{\circ}\text{C}$  lower than the preset temperature before stabilizing hot gas bypass volume (low limit alarm). At the same time, MSS2 is turned off; 20S2 and 20M are closed, after "pump down", the compressor stops to prevent over-cool.
  - f .If HS1 has been turned on during step "e" above, the electric heaters (H1 and H2) may be turned on tentatively, but they will be turned off when the temperature rises. (Refer to the section on Heating Operation for the details.)

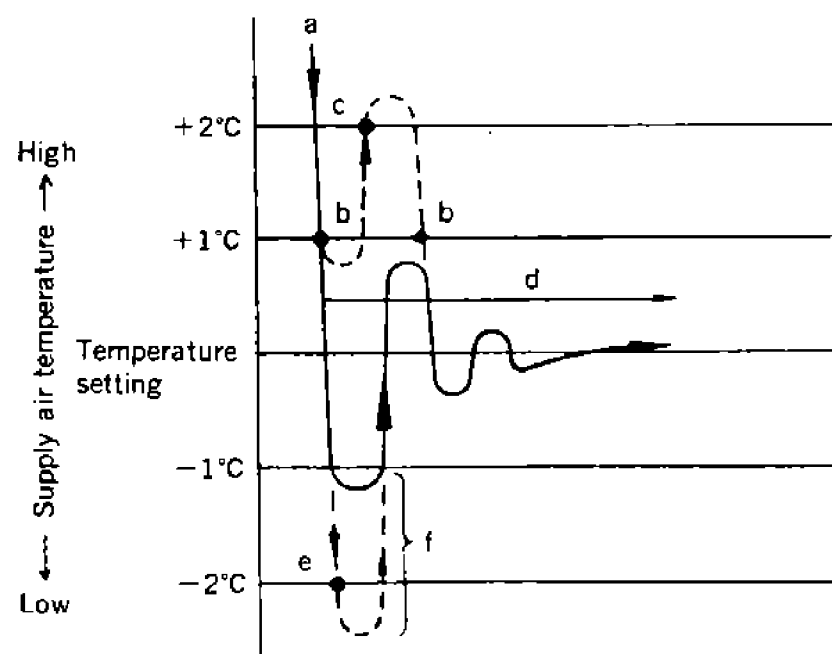

### 3.4 Heating operation

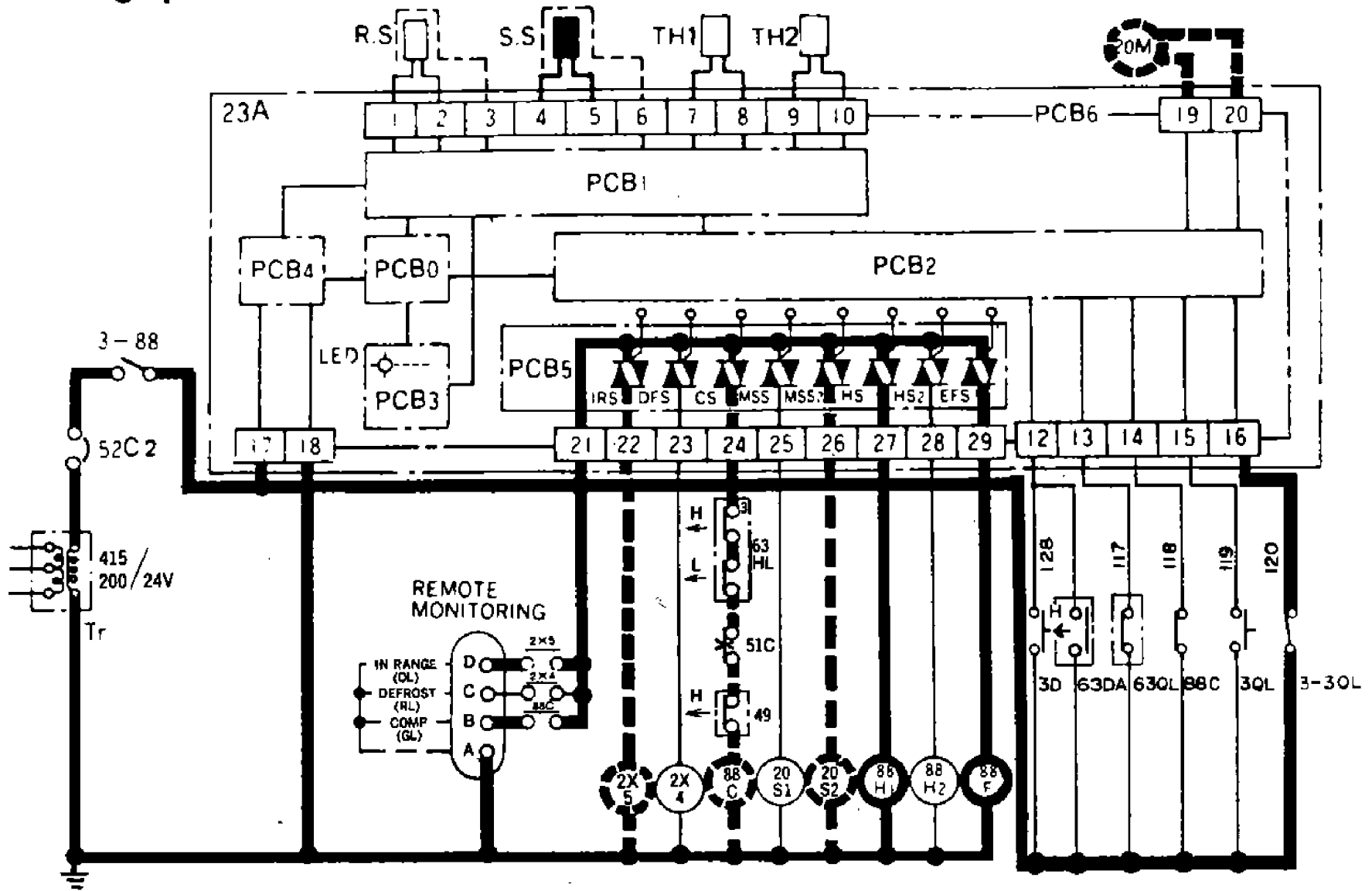

- (1) Heating operation will be performed only when the preset temperature is  $-5^{\circ}\text{C}$  or higher as in the chilled mode. Inside temperature will be controlled, sensing the supply air temperature.
- (2) There are three modes in the heating operation.
  - Pull up — Heated only by electric heaters
  - Steady state — Heated by hot gas bypass and electric heaters (when large heating capacity is needed)
    - Heated only by hot gas bypass (when small heating capacity is enough)

One of these three modes will be automatically selected according to load conditions.

- a. Pull up (The circuit indicated with bold lines in the sequence diagram functions)
  - If the supply air temperature is  $2^{\circ}\text{C}$  below the preset temperature, IRS is turned off, 20M closes, MSS2 is turned off, HS1 is turned on with "pump down" out of operation and electric heater H1, 2 are energized by 88H1.
- b. When the supply air temperature drops to the temperature setting minus  $1^{\circ}\text{C}$ , IRS is turned on and OL LAMP will light up. Simultaneously, 20M opens and MSS2 is turned on (20S2 opens), the compressor is started, and heating will start with the electric heater and hot gas (The heating circuit is shown with the dotted line on the sequence chart.)

- c. If heating load is small as stated in step "b", the inside temperature will rise: HS1 is turned off (the function point of HS1 varies depending on PID operation): 88H1 becomes unenergized: and the heaters (H1 and H2) are turned off, and heating operation only with hot gas bypass is performed. (The circuit is the same as that of chilled operation in the sequence diagram.)

Note: The tripping point of HS1 is determined depending on temperature and time by means of P.I.D. (P : proportional action, I : integral action, D : derivative action) of the controller.

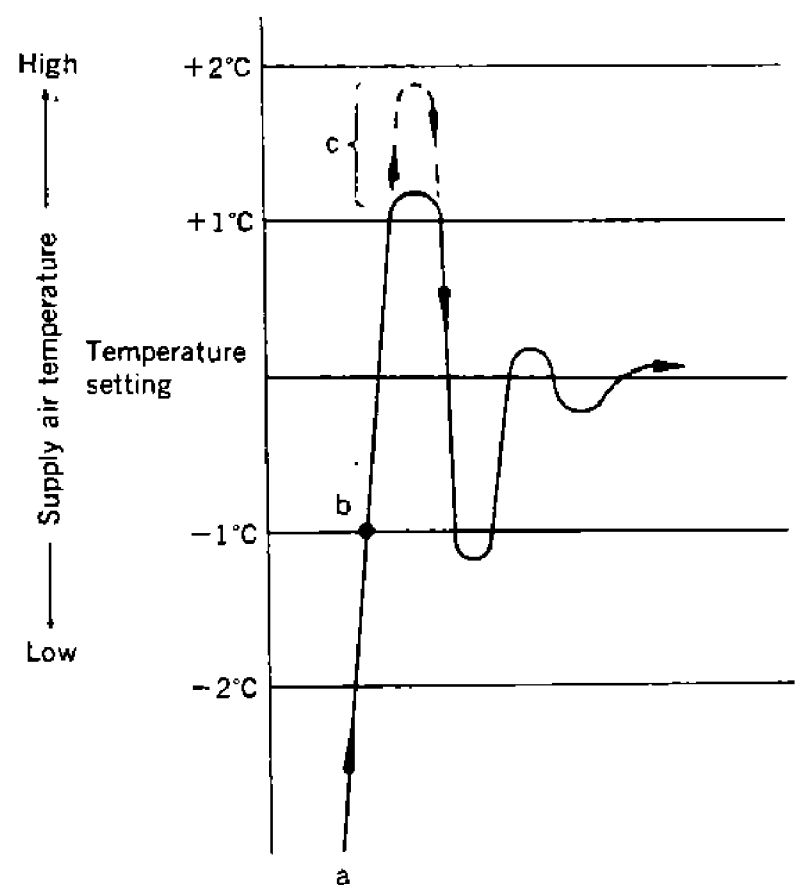

### 3.5 Defrost operation

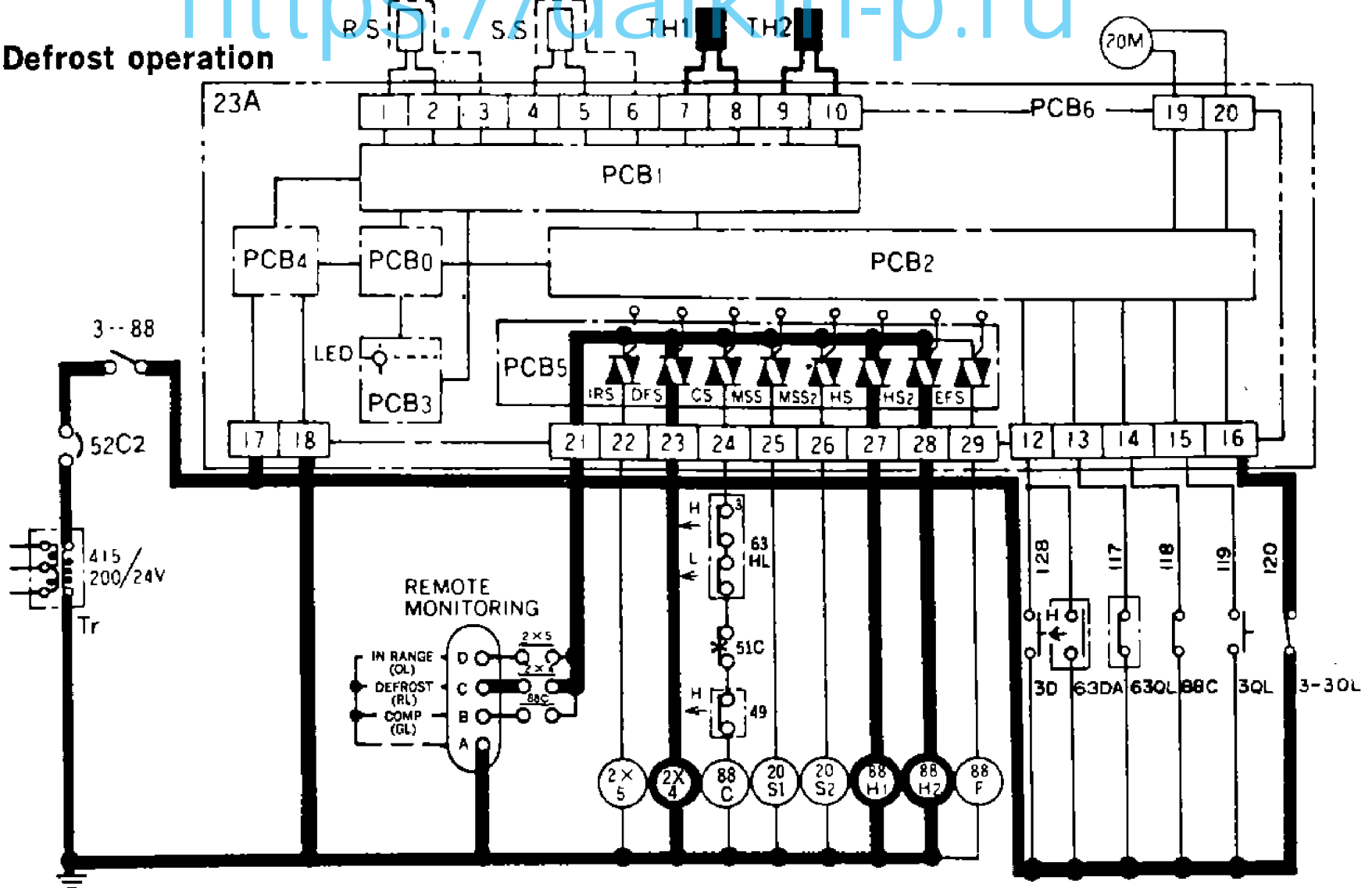

(1) Defrosting operation starts based on the following two conditions.

- Timer (incorporated in controller) counts up:  
The defrost cycle time is as follows.
  - When inside temperature is above "preset temperature + 2°C" (IRS-OFF); 4 hours
  - When inside temperature is below "preset temperature + 1°C" (IRS-ON); 12 hours
- Manual defrost switch (3D) or air pressure switch (63DA) is turned on.  
If one of those stated above is on, DFS is turned on and RL (red lamp) lights up.

(2) Simultaneously as DFS is turned on:

- 20M is closed. MSS1, 2 are turned off, 20S1, 2 are closed, and "pump down" stops. When 88C is turned off, HS1, 2 are turned on, 88H1, 2 are energized, and the electric heaters are energized. Simultaneously, EFS is turned off, evaporator fan motors MF1-1, 2 stop, and defrost operation starts.

### 3.6 High pressure control

(1) The condensing pressure (high pressure) falls when the ambient temperature falls during air-cooled operation, and the lower pressure also falls accordingly. If operation is still continued in this condition, the low pressure switch will be turned off (LP of 63HL is turned off) and the compressor will stop so that the required refrigeration capacity is not available. To prevent the high pressure from falling, a pressure switch (63CL) (which controls the high pressure) stops a condenser fan (MF-2-3) automatically when the high pressure falls to 7 kg/cm<sup>2</sup> (99.6 psi).

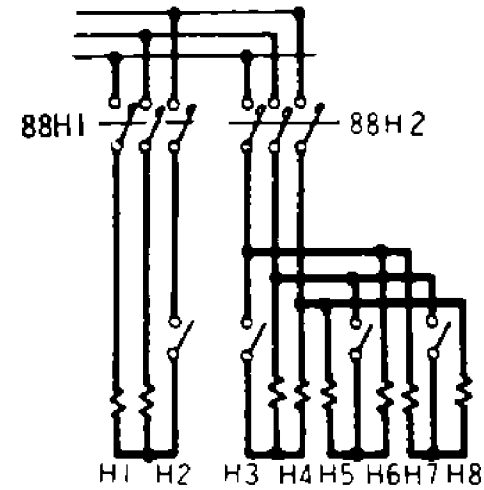

The circuit shows 200V class circuit.

(3) When the evaporator coil temperature rises to 40.6°C after having removed frost, (defrost temperature detects the coil temperature) DFS is turned off. Defrosting operation is terminated.

**Note:** If during defrost operation or heating operation, the temperature rises abnormally, (over 71°C, this is detected by the over-heat thermistor) and HS1, 2 are turned off, then the electric heaters are deenergized.

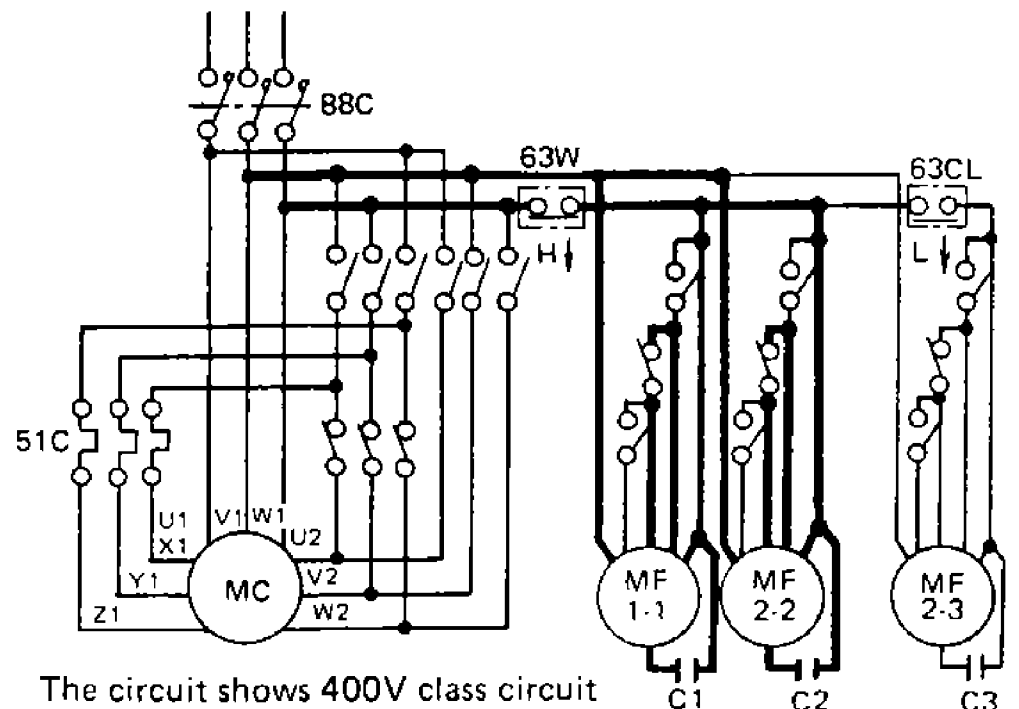

The circuit shows 400V class circuit



### 3.7 Air cooled and water cooled operation

The unit is possible to operate on either operations of air cooled or water cooled.

During the transit on the land, in the yard or on the deck, the air cooled operation is normal, and the operation in ship holds is normally water cooled. The operation can be changed from air cooled to water cooled and vice versa automatically by the water pressure switch; i.e. when water pressure at the inlet of the water cooled condenser rises higher than the presetting value, the contact points of the water pressure switch are cut out, so the condenser fan motors stop, and the water cooled operation starts. On the contrary, when water supply is suspended during the water cooled operation, the contact points of the water pressure switch come in contact and the condenser fan motors rotate. Thus, the air cooled operation starts.

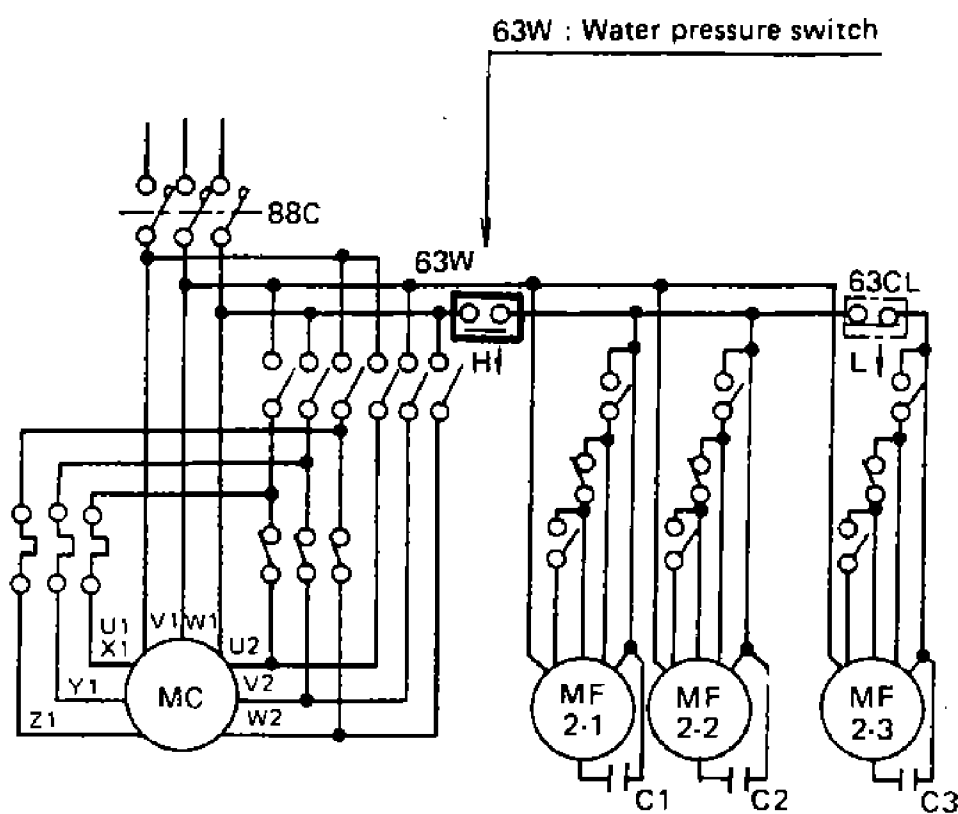

This diagram indicates air cooled operation mode. When water pressure is applied to the switch, the switch mechanism moves in the direction of H ↓, so the condenser fan motors (MF2-1, 2, 3) stop, and water cooled operation starts.

### 3.8 Pilot lamps and monitoring circuit

3 lamps (Light emitting diode) which indicate operating mode are mounted on the front panel of the controller in the control box and can be seen through the window if the cover of the control box is closed.

- **Comp. (Green)** ... Compressor operating
- **Defrost (Red)** ..... Defrost operating (DFS: ON)
- **In range (Orange)** **IN RANGE** (Inside temperature is in range ... setting temperature  $\pm 2^{\circ}\text{C}$ )

Receptacles for monitoring pilot lamps is also equipped and its connections are shown at below.

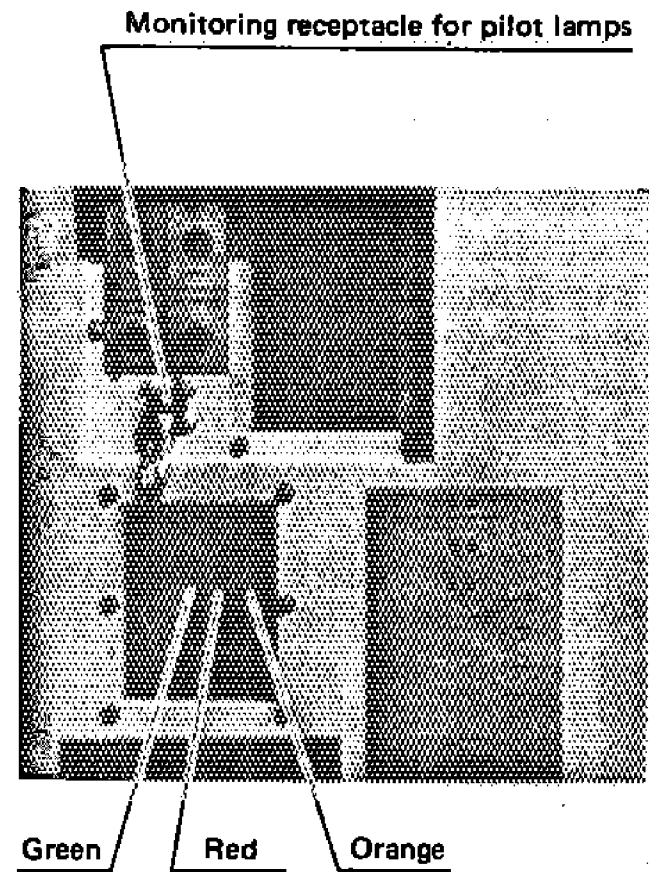
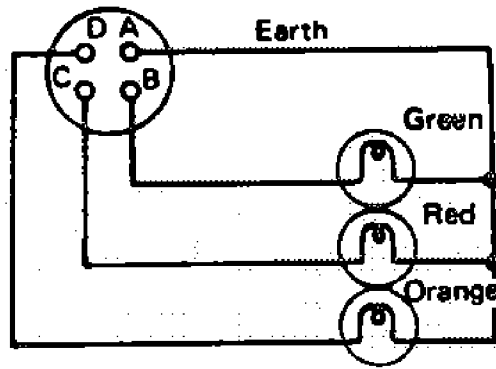

(2) How to judge operation state by pilot lamps and function of the components.

NAME	TEMPERATURE SETTING ABOVE -5°C (+23°F) - AIR COOLED OPERATION					TEMPERATURE SETTING BELOW -5°C (+23°F) - AIR COOLED OPERATION			WATER COOLED OPERATION
	COOLING		HEATING		DEFROST	COOLING		DEFROST	
	PULL DOWN	IN RANGE	PULL UP	IN RANGE		PULL DOWN	IN RANGE		
DEFROST - Red	×	×	×	×	○	×	×	○	WATER COOLED CONDITION IS THE SAME AS AIR COOLED EXCEPT • WATER PRESS. SWITCH (WPS) OPEN • CONDENSER FAN MOTOR (MF2) DE-ENERGIZED
COMP. - Green	○	○	×	○	×	○	○	×	
IN RANGE - Orange	×	○	×	○	○	×	○	○	
COMP. COND. FAN MOTOR (88C)	○	○	×	○	×	○	○	×	
EVAPORATOR FAN MOTOR (88F)	○	○	○	○	×	○	○	×	
HEATER (88H1)	×	×	○	○	○	×	×	○	
HEATER (88H2)	×	×	×	×	○	×	×	○	
SOLENOID VALVE (20S1)	○	×	×	×	×	○	○	×	
SOLENOID VALVE (20S2)	○	○	×	○	×	×	×	×	
MODULATING VALVE (20M)	×	○	×	○	×	×	×	×	
COMPRESSOR	○	○	×	○	×	○	○	×	

Notes 1. ○ : Energized or ON, × : De-energized or OFF

## 4. Major components and maintenance

### 4.1 Components related with refrigeration circuit

#### 4.1.1 Compressor

The compressor is of a semi-hermetic type with built-in motor so that there are few places where leakage of refrigerant may occur. The reversible lubricating oil pump used produces the required oil pressure regardless of the direction of rotation of the built-in motor.

##### (a) Replacement

Remove the compressor by the following procedure.

- 1 Remove the front and base plates and protective bar of the cable stowage.
- 2 Remove the discharge stop valve, suction stop valve gauge piping flare nut (compressor side) and cable.
- 3 Remove four bolts (two on each side) fastening the compressor and base.
- 4 Take out the compressor to the front of the unit.

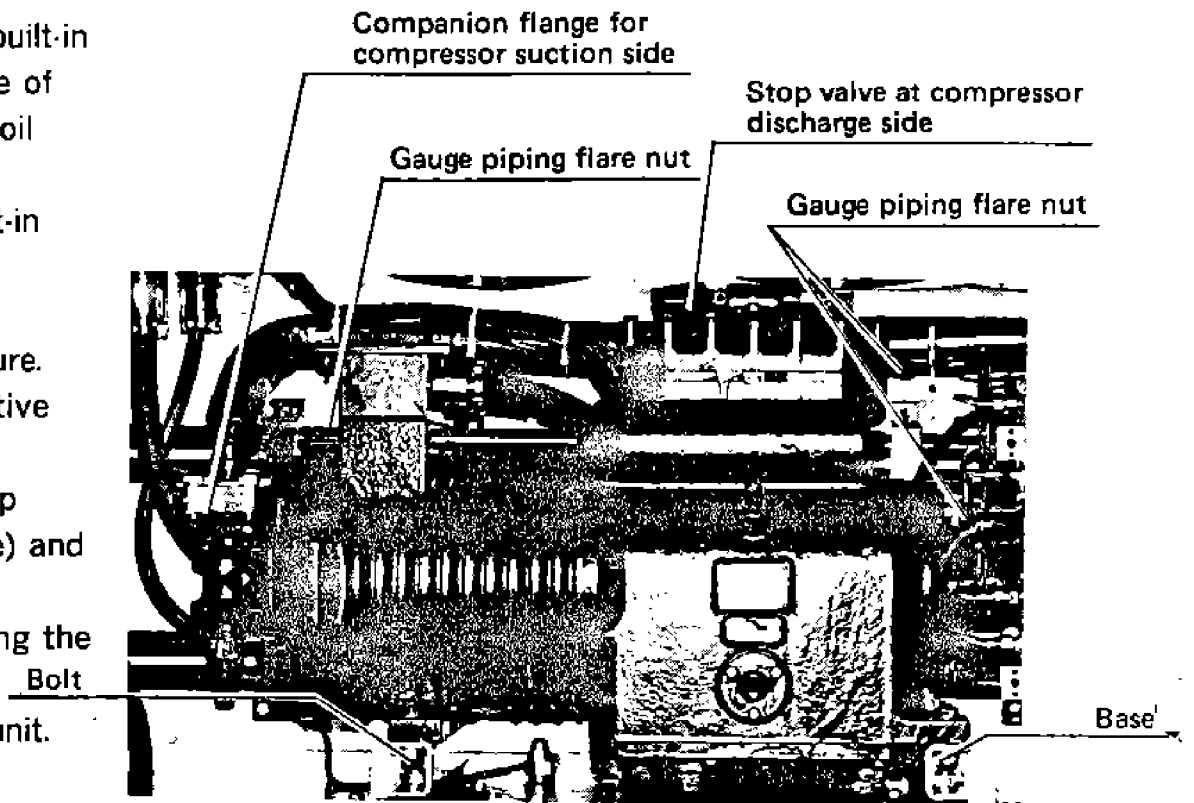

##### (b) Installing procedure

Install the compressor according to reverse procedure given above. When tightening the bolts, refer to the torque values listed.

#### 4.1.2 Air cooled condenser and evaporator

The "cross fin" coil has special corrugated fins. They are compact and very efficient in producing uniform heat exchange efficiency.

##### (a) Maintenance

Service the air cooled condenser after removing the air suction grille. Service the evaporator after removing the air return grille or the access panels from outside.

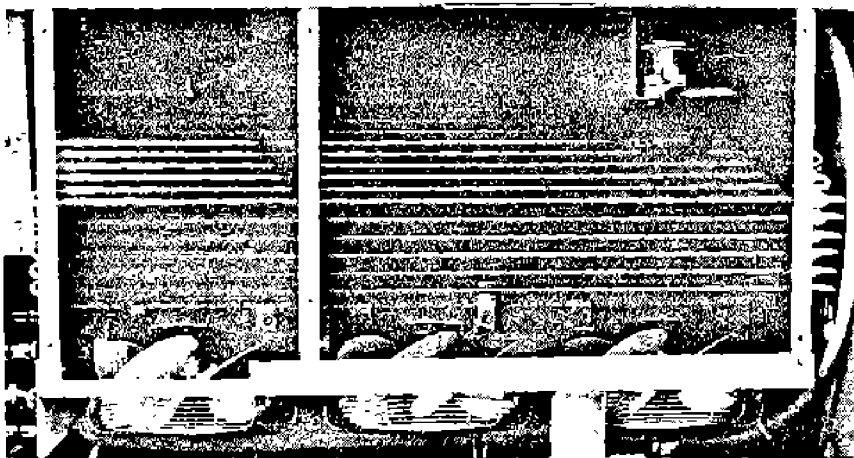

Air cooled condenser

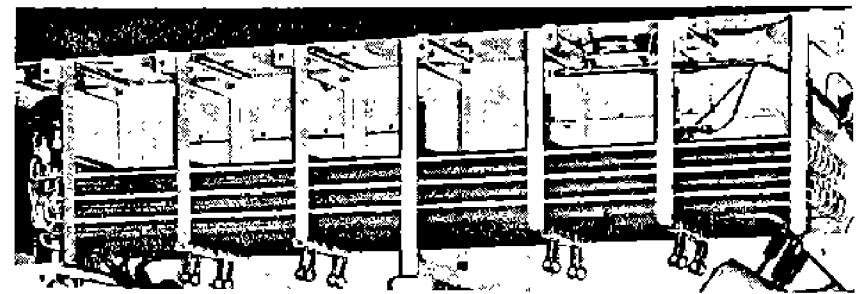

Evaporator

#### 4.1.3 Water cooled condenser

Of the tube-in-tube type in which cooling water flows in the inner tube while the refrigerant flows between the outside wall and the wall of the inner tube. Since special fins are fitted, the condenser is compact and light.

**4.1.4 Accumulator-receiver with heat exchanger**

Consists of the accumulator, receiver, and heat exchanger, which are encased in a vertical cylindrical construction ; i.e. the heat exchanger passes through the accumulator from its top to the bottom and reaches to the receiver.

This construction reduces heat loss. A fusible safety plug is fitted to the receiver body.

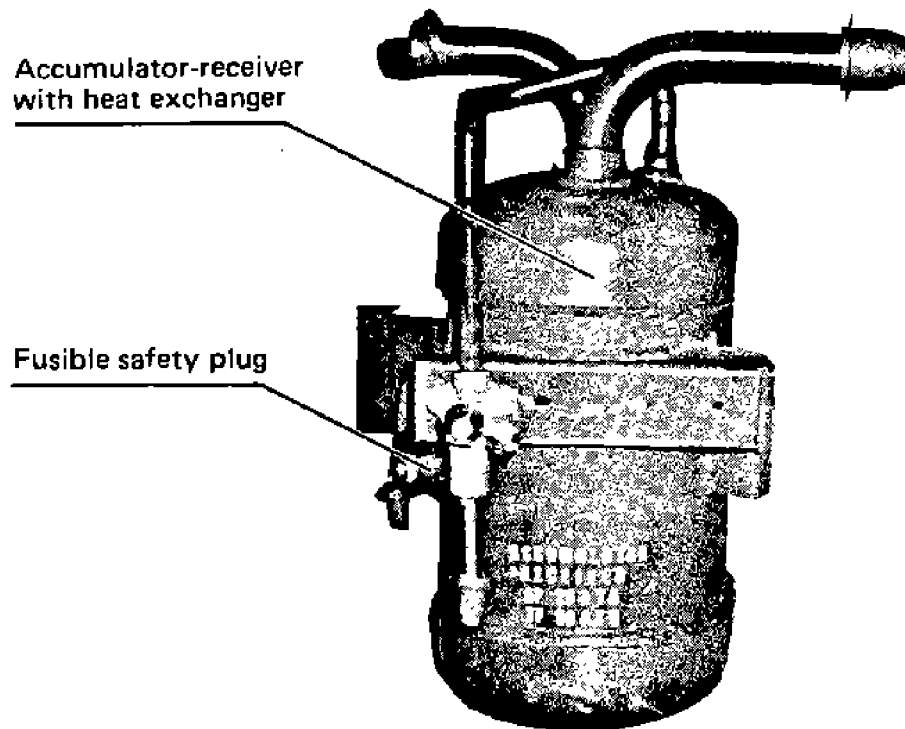

**(a) Replacement procedure of the fusible safety plug**

When pressure rises abnormally in the system, the fusible safety plug melts itself, so if the fusible safety plug is melted, check possible causes thoroughly. When fusible safety plug functions, the centre of the fusible safety plug alloy②melts, from which the refrigerant escapes. When the flare nut is removed,① (ball) will come out under pressure and block the passage of the refrigerant outlet, which prevents the refrigerant from escaping and also the air from entering. Thus, refrigerant loss is extremely minimized.

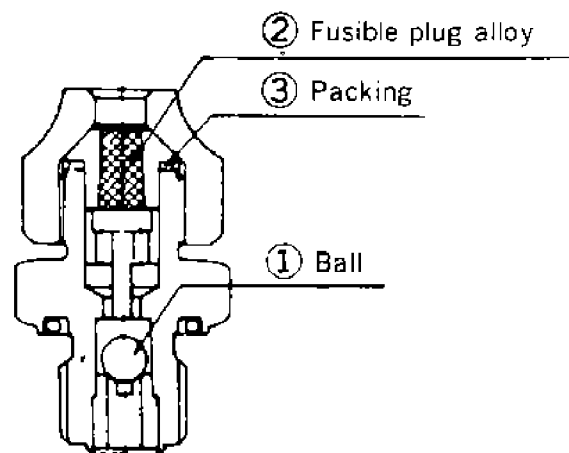

Construction of fusible safety plug

Insert a new ② with ③, and tighten the flare nut.

**4.1.5 Expansion valve**

The externally equalized thermal expansion valve which is fitted before the evaporator and senses over-heat degree of leaving evaporator refrigerant and controls flow of the refrigerant automatically according to operating conditions. The expansion valve with MOP (MAXIMUM OPERATING PRESSURE) is adopted to protect the compressor motor from overload.





“CAUTION” Whenever adjusting and replacing the expansion valve, the unit should be isolated from the mains supply for safety.

**(a) Adjusting the expansion valve**

There are two methods to adjust the expansion valve ; i.e. one is the adjustment based on the suction operation standard and the other is that based on the frost conditions on the compressor.

- (1) Adjustment based on the suction operation pressure
  - 1) Confirm that the predesigned volume of the refrigerant has been charged.
  - 2) Attach a pressure gauge to each gauge port and operate the refrigeration unit, maintaining inside temperature at  $-18^{\circ}\text{C}$  ( $-0.4^{\circ}\text{F}$ ). (See connecting of pressure gauge).
  - 3) When inside temperature comes to the preset temperature, compare the suction pressure reading with the standard pressure. (See standard operation pressure curve)
  - 4) If suction pressure reading differs with the standard pressure, adjust the expansion valve as stated below.
  - 5) After loosening the clamp screw, turn the adjusting screw.
  - 6) Note that pressure will not change after a certain lapse of time.
- (2) The adjustment based on frost stated on the compressor.
  - 1) Refer to the caution for adjustment of expansion valve as above. At this time, inside temperature should be maintained to  $-18^{\circ}\text{C}$  ( $-0.4^{\circ}\text{F}$ ).
  - 2) Regulate the adjusting screw as stated below based on frost state on the suction pipe and the stop valve of the compressor.
  - 3) Whether or not the adjustment required is judged by frost state of the flange on the suction side of the suction valve.
  - 4) However note that frost state differs with ambient air conditions (temperature and humidity).

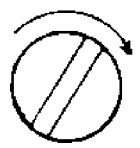
## Adjusting points for expansion valve

Adjusting screw	Turning direction		Operation state
Adjusting screw of expansion valve	Clockwise		Suction pressure is higher than the standard pressure (Frost forms on the suction pipe rather than the suction flange of the stop valve), Clockwise rotation of the adjusting screw decreases running pressure.
	Counter-clockwise		Suction pressure is lower than the standard pressure (frost forms on the compressor side rather than the suction flange of the stop valve). Counterclockwise rotation of the adjusting screw increases running pressure.

### (3) Countermeasures after operation

- 1) Remember the original setting of the expansion valve. If any change is not found with the setting after adjustment of the expansion valve, return the adjusting screw to the original position, as trouble occurred caused by other reasons.
- 2) When the adjusting screw is returned to its original position, firstly turn it passing the original position and then return it to the original position.
- 3) After adjustment, be sure to tighten up the clamp screw and cap it to prevent the refrigerant from leaking.
- 4) After completion of the adjustment, operate the unit, keeping inside temperature at  $-18^{\circ}\text{C}$  ( $-0.4^{\circ}\text{F}$ ) and confirm that low pressure is within the range of operating pressure at item 5.

### (b) Replacement

For replacement of the expansion valve, remove the access panel located on the front of the unit or by removing the evaporator bulkhead inside the container.

- 1) Remove the feeler tube, equalizing pipe flare, and fastening bolts. (To replace the cage alone, there is no need to remove the feeler tube.)
- 2) Remove the power assembly, cage, and packing.
- 3) Be sure to install a new packing when replacing it.

### 4.1.6 Liquid/moisture indicator

This indicator permits checking of flow of the refrigerant and moisture content in the refrigerant. Check this indicator during the unit is operating.

#### (a) Moisture content

The indicator indicates moisture content by the color at the center of the window.

Color	State
Green	Dry
Yellow	Wet (moisture contained)

Note : 1. The indicator may appear yellow if it has been exposed to gaseous refrigerant for a long time.

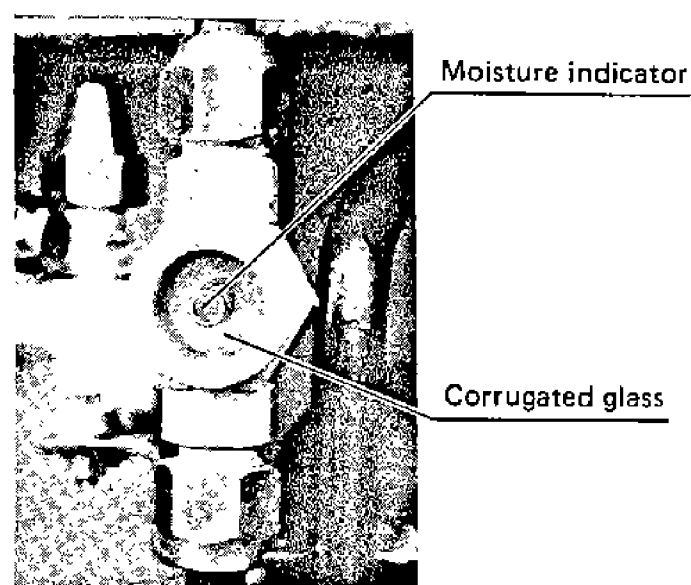
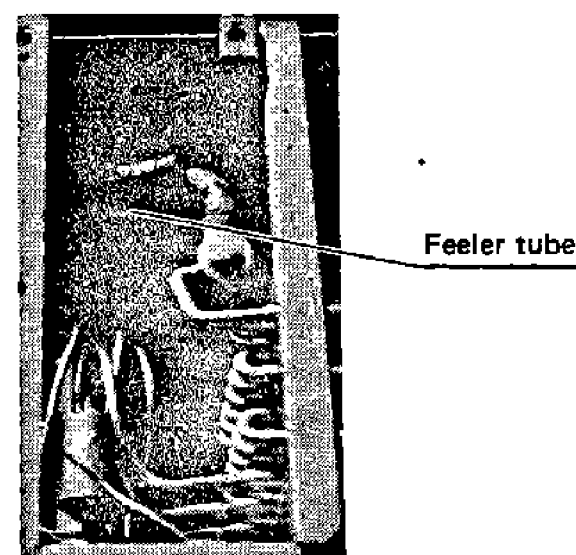
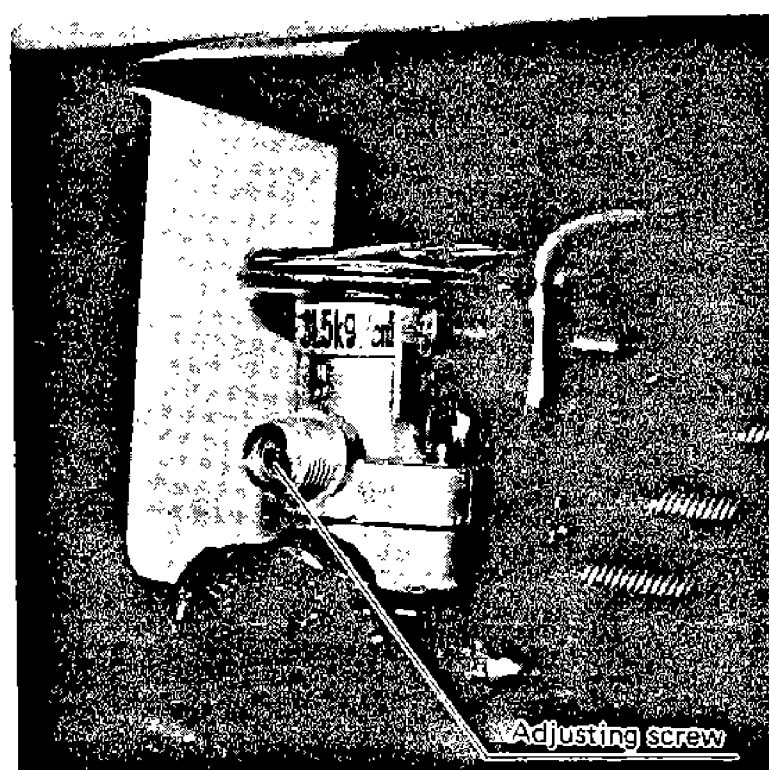

2. The indicator is to be checked at being sealed with liquid refrigerant after operating for a few hours.
3. Change of the indicator is influenced by the temperature of liquid refrigerant. The lower temperature cause the change of indicator to take the longer time.
4. To shorten the time for change of indicator, raise up the temperature of liquid refrigerant.

(b) **Flow of the refrigerant**

● **Check**

Operation	Indicator state
At start	Bubbles appear but liquid refrigerant is sealed in 30 minutes to an hour after starting.
During operation	Bubbles may appear more or less. { Particularly appear more during capacity control operation }

If bubbles develop continuously, the refrigerant is possibly running short.

**4.1.7 Dryer**

This removes moisture and dust from the refrigerant while it is circulated. Replace the dryer if it does not remove moisture or is clogged.

When installing the new dryer, follow the directions given on the nameplate and do not make any mistake about the direction of the dryer.

**(a) Replacement**

- 1) In "pump down" state (see Service), close the compressor suction stop valve.
- 2) Then, loosen the flares at the both end of the dryer and replace the dryer quickly.
- 3) Be careful not to get air into the piping on the solenoid valve side while removing the dryer.
- 4) After reattachment of the dryer, open the stop valve a little to purge the air in the dryer from the flare on the solenoid valve side and then close it at once.
- 5) Loosen the flare on the other side, forcedly turn off the low pressure of the dual pressure switch, turn on the master control switch and open the solenoid valve only to purge the air.
- 6) After completion of the work, restore the stop valves to its original state and then inspect the system for gas leakage. Ensure no gas leakage is found.

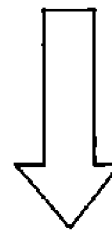

**4.1.8 Solenoid valves**

There are two solenoid valves (20S1 and 20S2) in the liquid line. They operate as follows according to operating mode.

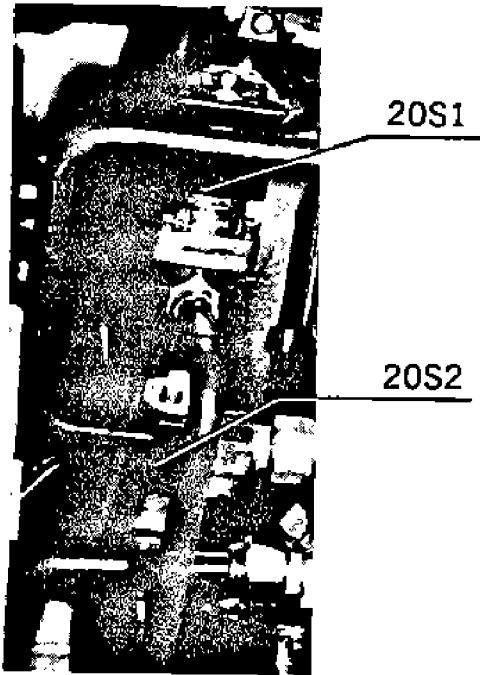

- (a) During frozen mode  
20S1 is open during operation.  
When stopping the compressor by the controller, it is closed and stop flow of the refrigerant, performing "pump down".
- (b) During chilled mode  
The two valves are open during "pull down".  
When the supply air temperature falls to the preset temperature plus 1.0°C, 20S1 alone is closed by directions of the controller. The refrigerant then flows through the capillary tube via 20S2 (liquid control).  
Both 20S1 and 20S2 are open When the solenoid is energized and closed when not energized.

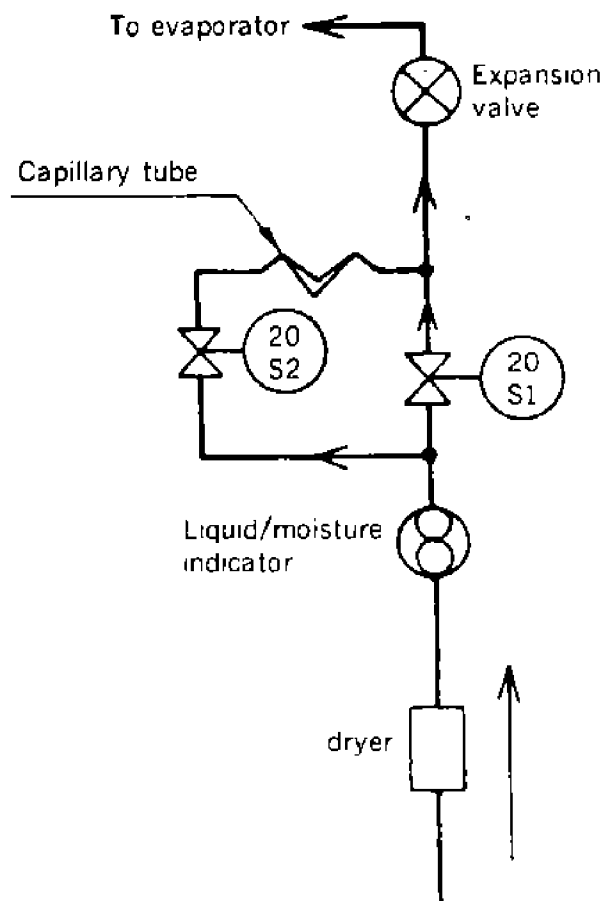

(c) Disassembly

- The structure of the solenoid valve is shown at below. (For disassembly, checking, and reassembly, refer to this diagram.)
- When brazing a pipe to the valve, cool the valve body with a wet cloth. (It is not required to disassemble the valve. Remove the coil ass'y from the body.)
- During reassembly, tighten the four bolts x4 with torque of 50–60 kg-cm.

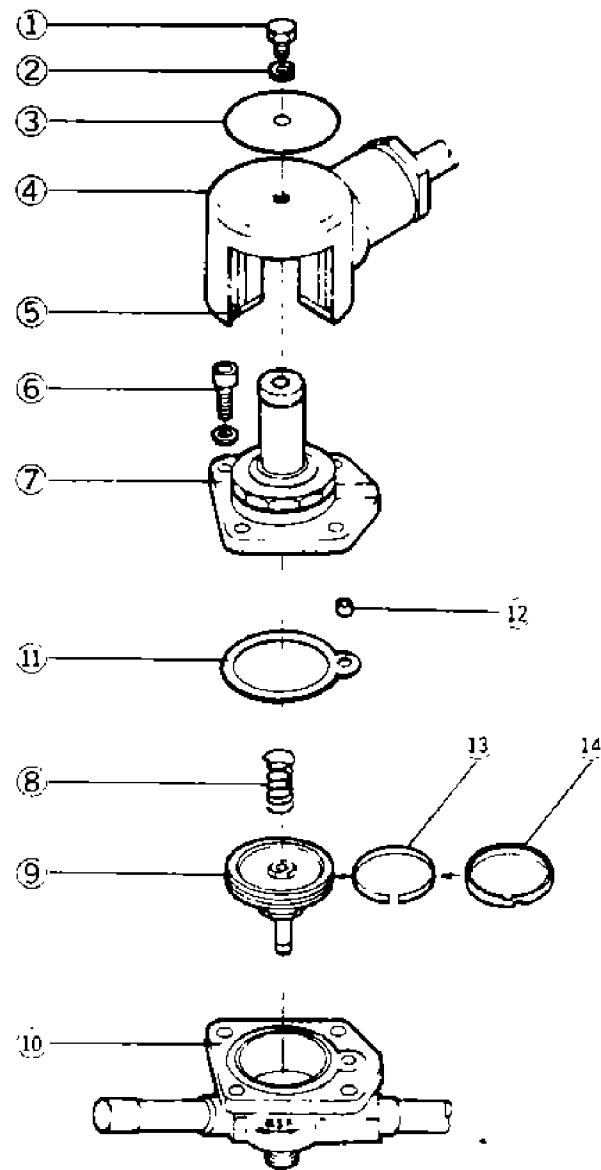

No.	Parts name
①	Set bolt
②	Spring lock washer
③	Name plate
④	Coil ass'y
⑤	Retaining plate
⑥	Set bolt
⑦	Cover ass'y
⑧	Spring
⑨	Piston
⑩	Valve body
⑪	Packing
⑫	Sleeve
⑬	Inner ring
⑭	Piston ring

**4.4. Components related with the air system**

**4.2.1 Fans and motors**

**(a) Specifications**

<Fan>

	Evaporator	Condenser
Type	Propeller fan	Propeller fan
Number of blades	6 pcs.	6 pcs.
Blade diameter	φ270	φ280

<Motor>

Type	Single-phase, squirrel-cage induction motor	
Motor output (number of poles)	465W (2P)	125W (4P)
Capacitor	Built-in	Separate
Bearing	Ball bearing, 6203 contactless type, rubber shield	

**(b) Installation procedure**

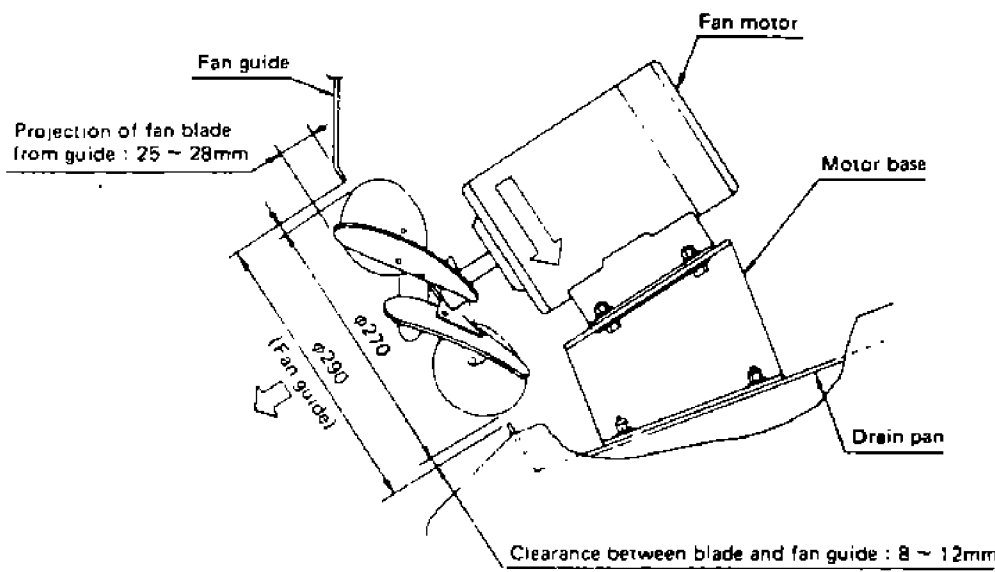

**Evaporator fan and motor**

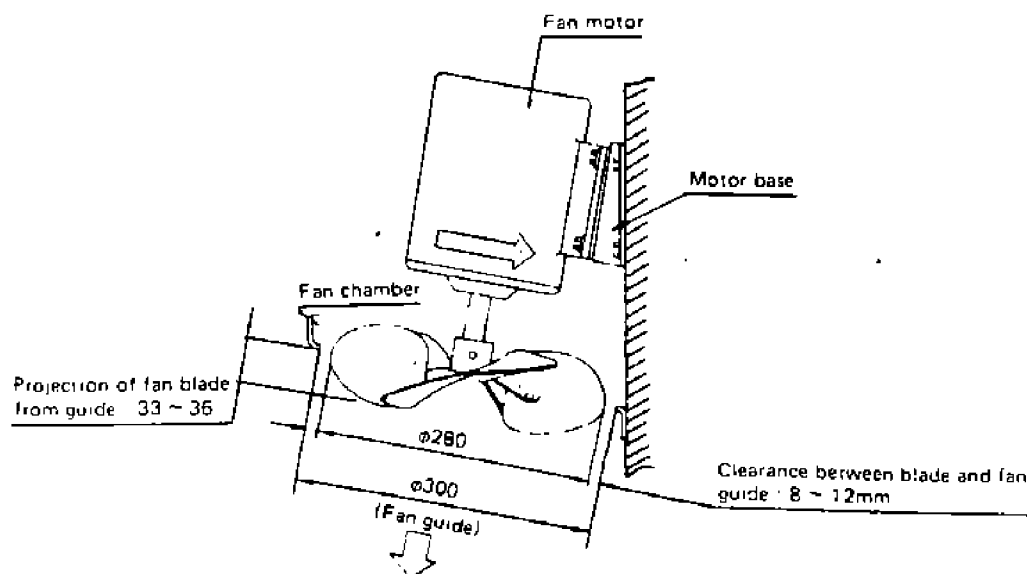

**Condenser fan and motor**

**4.2.2 Ventilator**

**■ Operation**

- If ventilation is not needed :  
Set the handle to CLOSED.

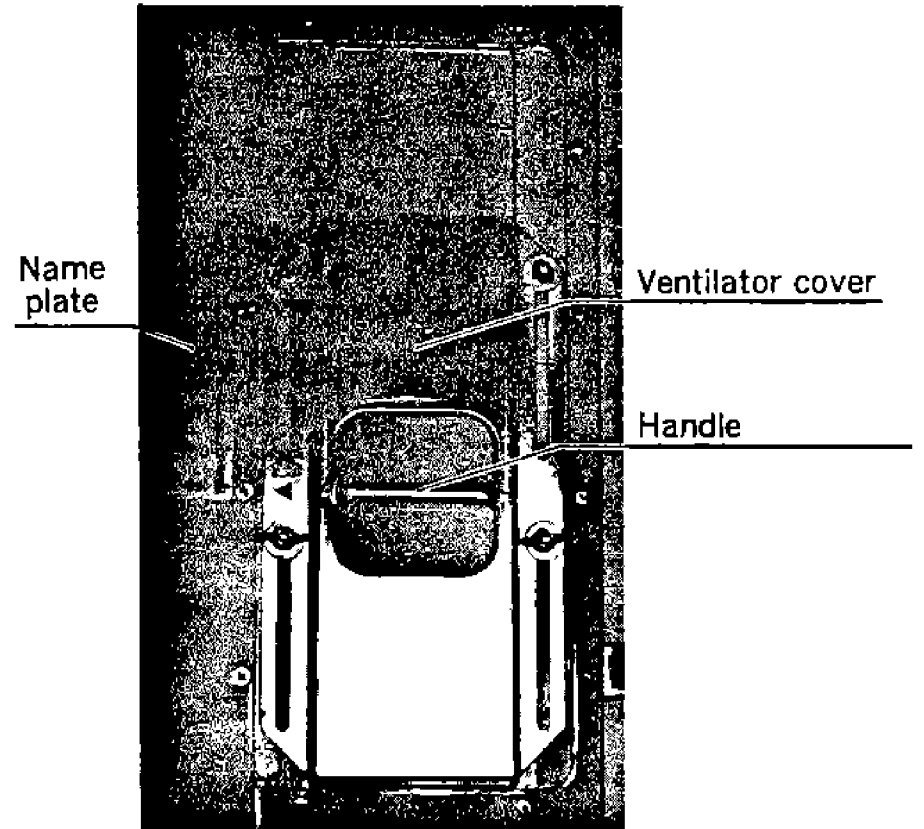

- If ventilation is needed :  
Set the handle to OPEN.

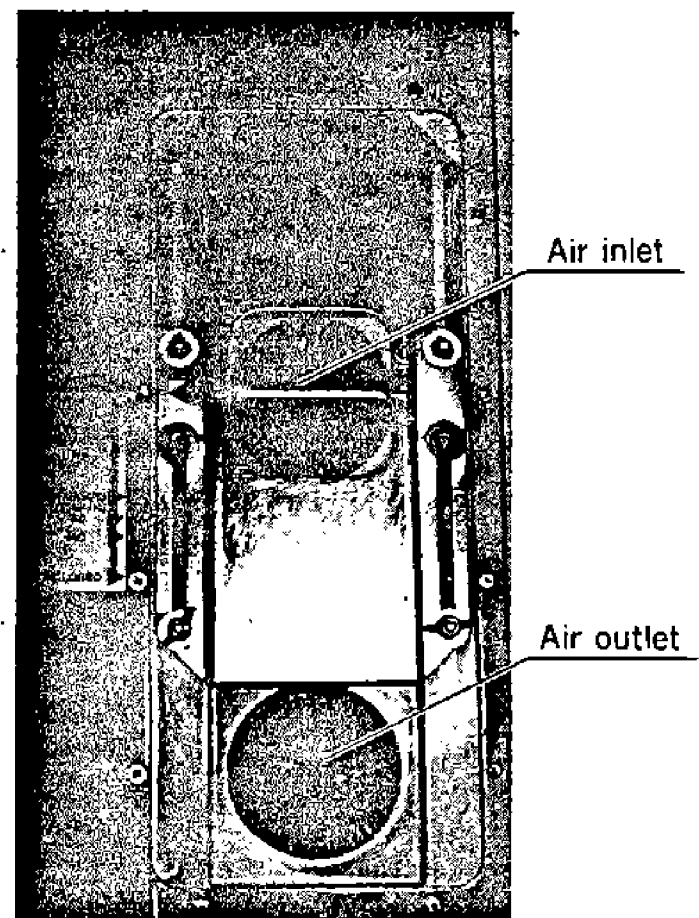



### 4.3 Temperature control system

This unit performs temperature control in three modes.

- I Frozen operation : compressor on-off control : Return air temperature is controlled (return air sensor).
  - II Chilled operation : capacity control by hot gas bypass
  - III Heating operation : capacity control by hot gas bypass
- } Supply air temperature is controlled (supply air sensor).

and electric heater control.

Selecting one of these operating modes automatically, the temperature control system controls the inside temperature according to the setting temperature and records it.

- The supply and return sensors will be automatically switched according to the setting temperature.
- The recorder records return temperature during operation

#### 4.3.1 Electronic controller DECOS I (Daikin Electronic Container Operation System) Model; DUE-DK83-102-67)

##### 1. Specification

- Power source .....AC24V, 50/60Hz
- Temperature range .....-29.9~+25.0°C
- Sensor
  - S.S : For supply air temperature control
  - R.S : For return air temperature control
  - TH1 : For defrost ter./detection
  - TH2 : For prevention of over-heat

} Platinum resistance thermometer element 0°C 100Ω

— Thermistor element
- Electronic Timer
  - Defrost timer (out-range) — 4hr
  - Defrost timer (in-range) — 12hr
  - Oil pressure Alarm detection timer — 110 sec.
  - Restart delay timer — 120 sec.
- Output
  - Solidstate relay for ON/OFF
    - IRS (For in-range), MSS1, 2 (For solenoid operated valves)
    - CS (For compressor), HS1 (For electric heater)
    - DFS (For defrost), HS2 (For electric heater)
    - EFS (For evaporator fan motor)
  - Valve control voltage adjustment by PID operation

} Step thermostat
- Display
  - Digital temperature display
    - Supply air temp.
    - Return air temp.
    - Setting temp.

} Change the digital temp. indication switch on the display panel.
  - Light emitting diode (LED)
    - Operation Displays —For each relay output (HS, EFS, MSS1, 2), operation mode/sensor (CHILLED-SUPPLY, FROZEN-RETURN) defrost test. (DEF. TEST)
    - Alarm Displays —Supply air sensor, return air sensor, oil pressure alarm (ALARM-OIL PRESS.) and defrost thermistor (ALARM-DEF. SENSOR)
- Others
  - Defrost timer check function.
  - Supply and return air sensor back up function.
  - Solenoid valve back up function
  - Defrost back up function
  - Relay check function
  - Oil protect function
  - Cold start function

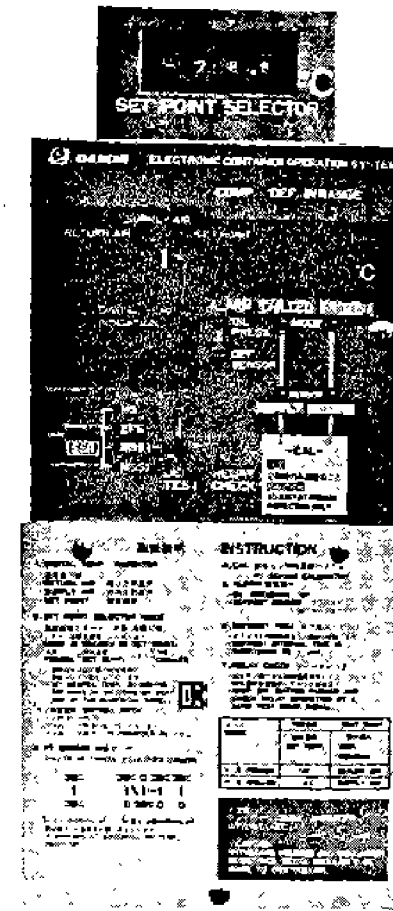

2. Operation and display

1) Temperature setting

- Set the set point selector located in the upper part of the controller to the specified temperature.  
Setting range : Variable range -29.9~+29.9°C  
Note that the range +25.1~29.9°C is regarded as a set temperature of 25.0°C, and the digital temperature display will indicate 25.0°C
- When the digital temperature display switch is set to the position for the set point, the value set by the switch is digitally displayed.

**Note 1.** Do not stop the switch unduly at intermediary positions. Allow digits to appear properly in the windows.

**Note 2.**

The column for 10°C displays only 0,1 or 2.  
Don't apply undue force.

**Note 3.** Don't touch the set point selector unless this is required to set temperature !

2) Measurement of supply and return air temperatures

- Set the digital temp. indication switch ("DIGITAL TEMP. INDICATION SWITCH") to "SUPPLY" ... supply air temperature display.  
to "RETURN" ... return air temperature display.

**NOTE :** "E" is displayed when the control sensor is abnormal.

"E" is displayed at "SUPPLY" position when the supply air sensor (S.S) is abnormal. "E" is displayed at "RETURN" position when the return air sensor (R.S) is abnormal.

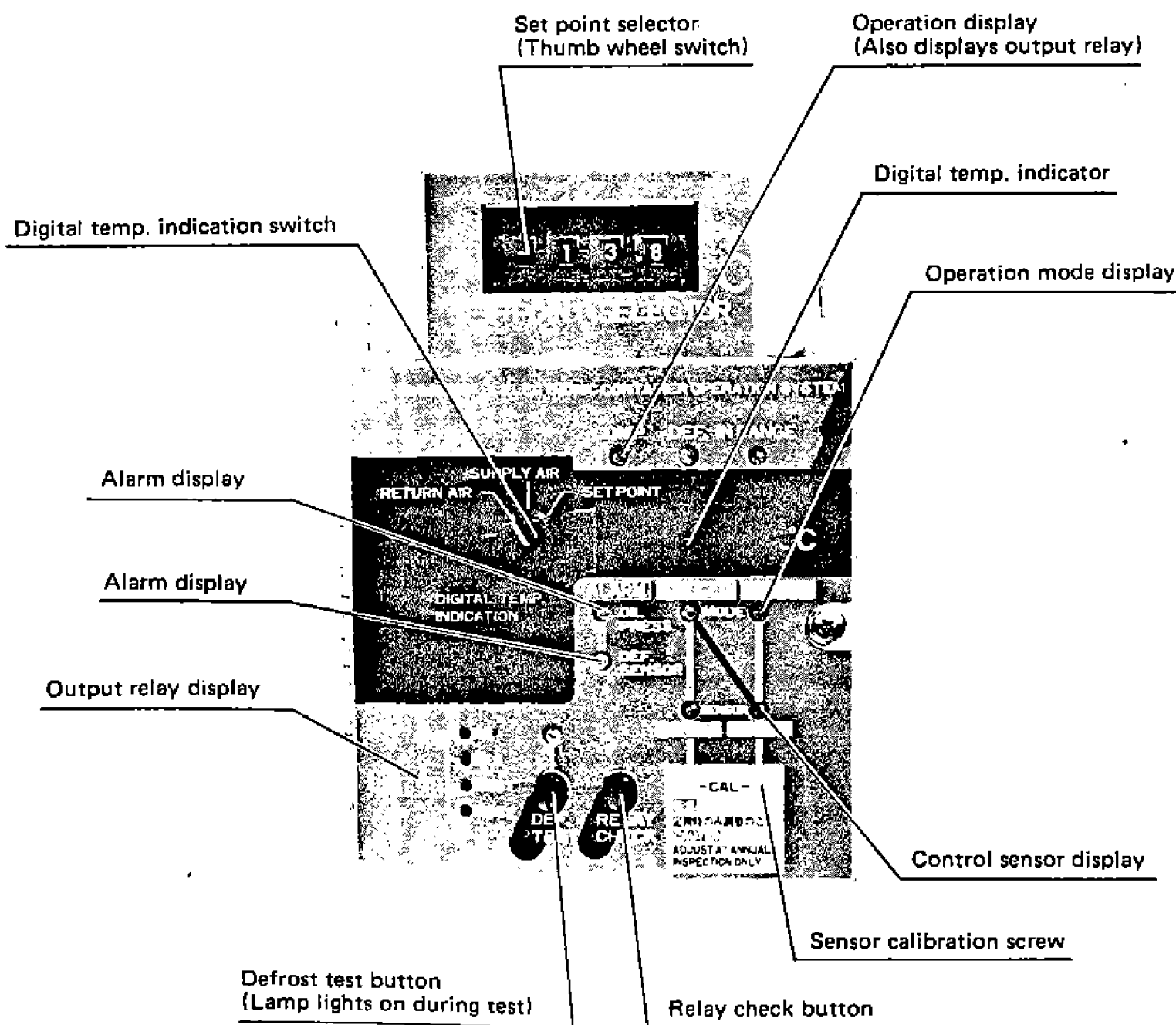

**3) Operation mode confirmation**

The operation mode and control sensor are automatically changed by the setting temperature.

**(a) Setting temperature above -5°C (CHILLED MODE)**

- CHILLED MODE lamp and SUPPLY SENSOR lamp (green) light on.
- When attaining to "in-range" (setting temperature + 1°C) from pull down (MSS1 and 2 turn on, modulating valve closes), MSS1 turns off, capillary tube controls liquid refrigerant and the modulating valve starts opening. Then, capacity control by hot gas bypass starts.

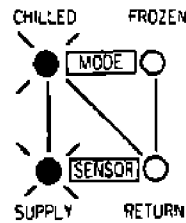

**(b) Setting below -5°C (FROZEN MODE)**

- FROZEN MODE and RETURN SENSOR lamp (orange) light on.
- Capacity control stops, and compressor ON/OFF control by full capacity starts.

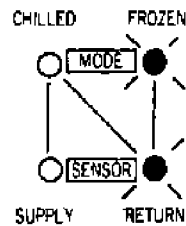

**4) Display function**

**(a) Opening display**

- Comp. (Green) ..... Compressor operating
- Defrost (Red) ..... Defrost operating (DFS : ON)
- In range (Orange) ... IN RANGE (inside temperature is in range ... setting temperature ± 2°C.)

**(b) Output relay operation display (Red)**

- SSR
  - HS ..... HS1: ON (heating operation) or HS1, 2: ON (defrost operation)
  - EFS ..... For 88F·ON/OFF
  - MSS1 ... 20S1·ON/OFF
  - MSS2 ... 20S2·ON/OFF

**(c) Alarm display**

- ALARM
  - OIL PRESS.
    - ... When the reset switch is turned on within 120 seconds after oil pressure alarm display signalled abnormal oil pressure, the ALARM lamp flickers.
  - DEF. SENSOR
    - ... Displayed short circuit or broken wire of the defrost thermistor.

● Control sensor (S.S, R.S) alarm

	NORMAL	SUPPLY SENSOR ABNORMAL	RETURN SENSOR ABNORMAL	SUPPLY and RETURN SENSORS ABNORMAL
CHILLED MODE				
FROZEN MODE				

**5) Defrost test**

- Pushing the "DEF. TEST" button the defrost test lamp (red) will light up and the defrost timer will start counting simultaneously.

NOTE ; Do not keep to push the button continuously.

- Defrost starting (after pushing the button)
  - In range (when IRS is on).....defrost starts (defrost lamp lights) after 43 sec. (12hr/1000)
  - In range (when IRS is on).....defrost starts (defrost lamp lights) after 14 sec. (4Hr/1000)
- The defrost test lamp lights off after defrosting.

NOTES 1. Defrost operation will not start even after the completion of time counting of the defrost timer when the temperature sensed by defrost completion thermostat is above 40.6°C. At this time, the defrost test lamp will go out also after the timer count up.  
2. Press the defrost test button and the standard timer (4hr or 12hr) is cleared.

**6) Sensor calibration (S.S, R.S)**

NOTE : DO NOT ADJUST EXCEPT DURING PERIODICAL INSPECTION !

- Adjust by turning the sensor calibration screw "CAL".
- Dip the sensor (S.S or R.S) in the ice water. Then adjust the digital temperature display valve of "SUPPLY" or "RETURN" air sensor to show 0°C.

Adjustment of temperature



**7) Relay (step) check**

- a. Relay function point of the step thermostat can be easily checked. Refer to "Relay Function Pattern" regarding relay function points.
- b. Press the "relay check button", and S.S and R.S are disconnected automatically from the controller and the temperature setting is also changed forcedly as follows.

Relay check : State before pushing the button	Relay check : During pushing the button		
	Digital temperature display value		
	SET POINT	SUPPLY AIR	RETURN AIR
In CHILLED MODE 	0°C	Auto swing temperature (see°C) is displayed instead of temperature sensed by S.S	Storage temperature sensed by R.S is displayed.
In FROZEN MODE 	-18°C	Storage temperature sensed by S.S is displayed.	Auto swing temperature (see°C) is displayed instead of temperature sensed by R.S

**c. Checking methods**

- Set the digital temperature display switch to "SUPPLY AIR" ("RETURN AIR").

Continue to press the relay check button, and digital temperature display swings as shown below centering on 0°C (-18°C), as false variation of inside temperature, and each output relay performs in step (Which is confirmed by LED). The digital temperature display value at this time corresponds to the relay function point.

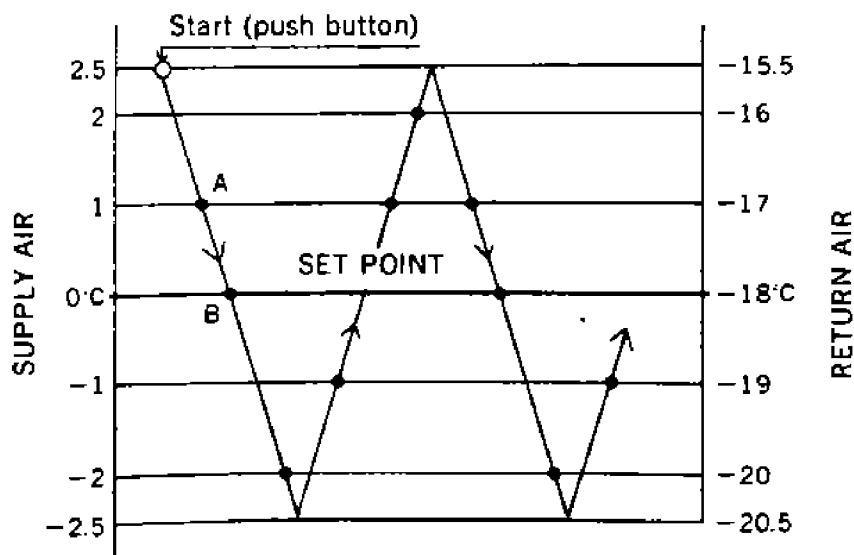

**1. Operation example :**

	CHILLED	FROZEN
Point A	MSS1→OFF, IRS→ON	IRS→ON
Point B	—	MSS1→OFF

- 2. Auto swing varies at the rate of 0.1°C/ sec.
- 3. When the relay check button replaced, the unit is returned immediately to the normal control.

**3. "Defrost" function**

**1) Defrost Initiation**

- Manual defrost switch (3D)
- Electronic timer
- Out range (setting temperature above +2°C) ...4hr
- In range (setting temperature below +1°C) ...12hr

**2) Defrost termination**

- Temperature is detected by the defrost thermistor.
- Defrost is terminated above +40.6°C OFF point (ON point is +23.6°C)

**3) "Defrost" thermistor back-up function**

- When the thermistor is not operating well, the defrosting can almost operate normally.
- Setting temperature ≥ 7.5°C — Not defrosting.
- Setting temperature < 7.5°C — Defrosting is initiated by the defrost initiation signal (in accordance with(1)). Automatically terminated by the 50-minutes timer.

**4) Cold start function**

- During defrosting, the evaporator fans are in halt.
- After defrosting, the evaporator fans are delayed for re-starting to avoid that the warm air by defrosting flow out of the unit until the evaporator is cooled down sufficiently.

**4. Sensor back-up function**

The following function automatically activates when the control sensor has a broken wire, or is short circuited.

**1) CHILLED MODE**

- When the supply air sensor (S.S) is abnormal. Automatically changes to the return air sensor (R.S). Controls the return air temperature +2°C higher than the setting temperature during supply air control with capacity control operation.
- When both supply and return air sensors are abnormal. Automatically stops the compressor.

**2) FROZEN MODE**

- When the return air sensor is abnormal. The compressor is operated continuously.

**5. Solenoid valve back-up function (during FROZEN MODE)**

- When the inside temperature is low than the in range ( $-2^{\circ}\text{C}$  below the setting temperature) without pump-down stop even though the solenoid valve (MSS1, 2 ... OFF) is closed, the compressor is immediately stopped. (CS OFF $\rightarrow$ 88C OFF)
- When this operation is continued, inside temperature is controlled in cycles of :
  - OFF ..... setting temperature $-2^{\circ}\text{C}$
  - ON ..... setting temperature $+1^{\circ}\text{C}$

Note : When a b-contact of compressor magnetic switch (88C), which is connected to the controller terminal No. 14, is failed in contact, the following phenomena are shown.

1. In spite of the compressor stops, the "COMP" lamp (Green) of electronic controller lights on.  
In such a case, it also caused by the actuation of oil pressure protection system.
2. In spite of "DEF" lamp (Red) of electronic controller lights on, "HS1" and "HS2" of SSR do not turn on, so that the electric heaters do not turn on.

In above case, check the b-contact of 88C whether it is failed or not in contact, and if it is failed replace "88C" with new one.

**6. Temperature control operation**

**1) FROZEN MODE (setting temperature below  $-5^{\circ}\text{C}$ , return air sensor)**

- a . Compressor ON/OFF control (control of 20S1 by MSS1)
- b . The modulating valve is fully closed, and capacity control is not performed. MV (modulating valve voltage) : 0V.
- c . MSS1, CS, IRS—Thermo operation

**2) CHILLED MODE (setting temperature above  $-5^{\circ}\text{C}$ , supply air sensor)**

- a . Pull down ..... Full capacity operation. Both 20S1 and 20S2 are opened. (ON by MSS1)
- b . Pull up ..... Heated only by electric heater (88H1 turned on by HS1)
- c . Inside In range... IRS turns on, supply air temperature is controlled continuously by combining the following three operations

- Liquid control only by 20S2 (20S1 is closed)
- Hot gas bypass control by modulating valve (20M) (PID operation)
- Heating by electric heaters (H1 and H2) (PID)
  - P ..... Proportional operation
  - I ..... Integral operation
  - D ..... Derivative operation
- The voltage (MV) to the propotional valve and ON/OFF points of HS1 are controlled in accordance with the differential between the temperature setting and supply air temperature (return air temperature in case S.S is abnormal).
- Modulating valve voltage (MV) : 0~20V DC

<Function pattern>

OUTPUT	MODE	SENSOR	Setting Temperature °C										
			-5	-4	-3	-2	-1	1	2	3	4	5	
MSS1	CHILLED	NORMAL (S.S)			OFF					ON			
		ABNORMAL (R.S)			OFF						ON		
	FROZEN	NORMAL (R.S)			OFF						ON		
		ABNORMAL (S.S)					ON						
MSS2	CHILLED (FROZEN : OFF)	NORMAL (S.S)			OFF						ON		
		ABNORMAL (R.S)			OFF						ON		
IRS	CHILLED	NORMAL (S.S)			OFF			ON					
		ABNORMAL (R.S)			OFF				ON				
	FROZEN	NORMAL (R.S)			OFF				ON				
		ABNORMAL (S.S)						ON					
CS	FROZEN (CHILLED : ON)	NORMAL (R.S)			OFF							ON	
		ABNORMAL (S.S)						ON					
MV HSI	CHILLED (FROZEN : OFF)	NORMAL (S.S)											
		ABNORMAL (R.S)	<p>NOTES 1) The diagram above shows only P operation. ID operation makes changes with combination of temperature and time. -t1, t2 (°C) and MV.                  2) HSI is always turned ON when below the lower limit of IR (temperature setting minus 2°C)</p>										
HS2 DFS	FROZEN CHILLED	——	Turned on only during defrost time.										
EFS	FROZEN CHILLED	——	Turned off only during defrost time.										
MODE CHANGE													
DEFROST THERMISTOR													
OVER-HEAT THERMISTOR													

● Supply and return air sensor are abnormal

	MSS 1	MSS 2	IR	CS	MV	HS 1	HS 2	EFS
CHILLED	OFF	OFF	OFF	OFF	OV	OFF	OFF	ON
FROZEN	ON	OFF	OFF	ON	OV	OFF	OFF	ON

**7. Printed circuit board (PCB)**

1) PCB functions

a) CPU PCB (PCB-0)

- Consists of CPU, ROM, RAM, display controller, interval timer, and input/output controller.
- Processes all input/output signals.

b) Analog PCB (PCB-1)

- Consists of amplification circuit, fault sensing circuit and A/D converter circuit.
- Temperature input signals from all sensors are amplified by amplification circuit, enter as analog signals into A/D converter circuit to be converted into digital signals, and transmitted to CPU PCB.
- Analog signals from temperature setting knob and phase control circuit etc. are also converted into digital signals by A/D converter circuit and transmitted to CPU PCB.
- Values set by digital switch are transmitted to CPU PCB.

c) Input/output PCB (PCB-2)

- Consists of buffer circuit, phase control circuit, and amplification circuit.
- Input signal from external contact is received by buffer circuit and transmitted to CPU PCB.
- Transmits phase control signal to analog PCB and CPU PCB for power amplification of phase control signal and applies to modulating valve (20M).

d) Display PCB (PCB-3)

- Consists of light emitting diode, digital display circuit, diode matrix circuit, temperature setting volume, and various switches.
- Receives display signal from CPU PCB to display by means of light emitting diode (LED) or digital display.
- Transmits switch signal on PCB to CPU PCB.
- Transmits analog signals from temperature setting volume and CAL volume to analog PCB.

e) Power source PCB (PCB-4)

- Consists of rectification circuit and constant voltage circuit and supplies power to electronic circuits.

f) SSR PCB (PCB-5)

- Consists of SSR (no contact relay) and photo coupler.
- Isolates output signal from CPU PCB by means of photo coupler and drives SSR.

g) Terminal PCB (PCB-6)

- Consists of terminals to provide external wiring connections with this unit.

h) Thumbwheel PCB (PCB-7)

- Consists of top of the controller to the thumb wheel switch. (setting PID)

2) External wiring (wiring to terminal PCB, PCB-6)

All the external wiring (input and output) to the controller should be connected to the terminal board (PCB-6).

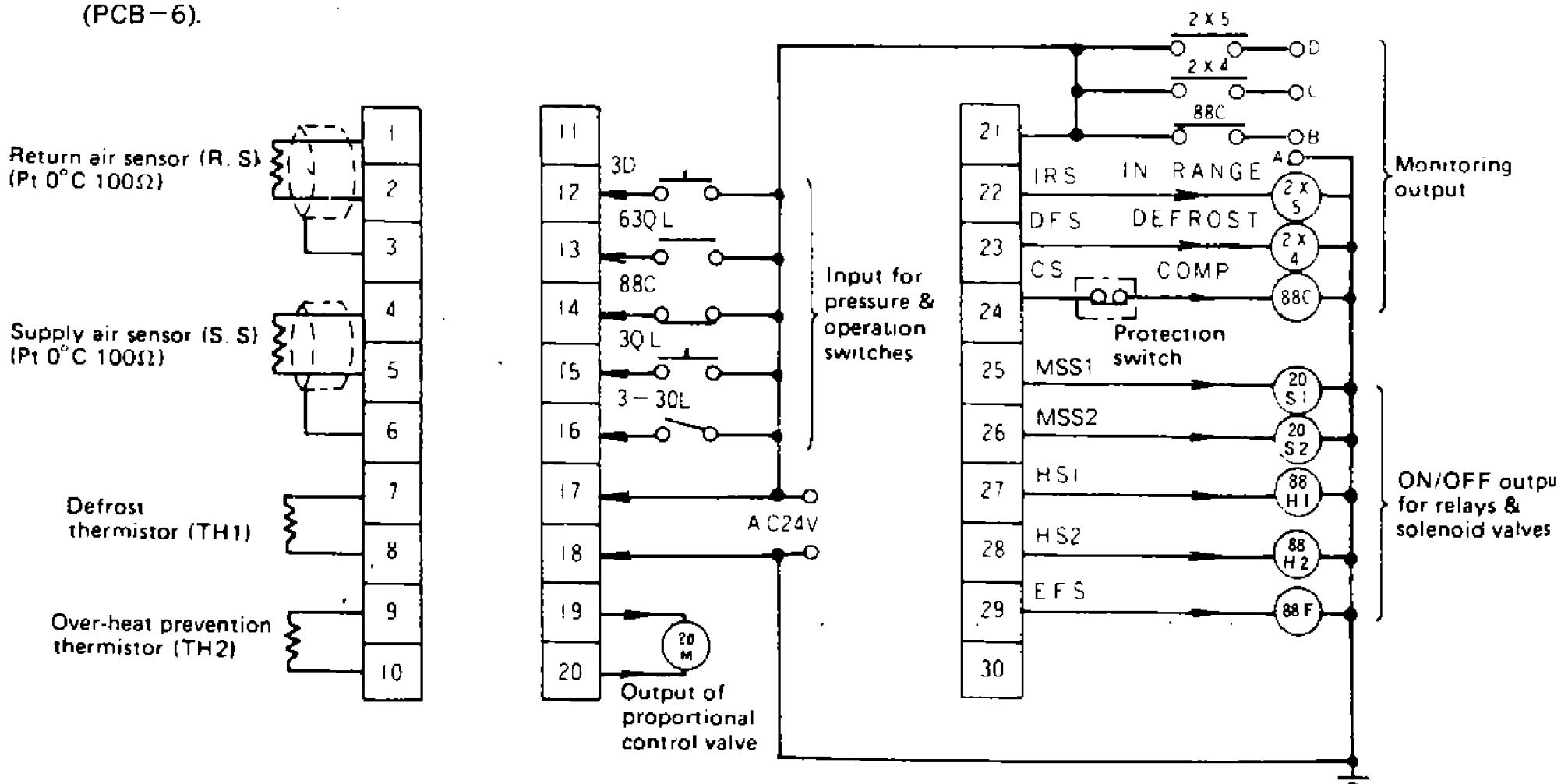

**IMPORTANT :**

1) Do not accomplish withstand voltage tests or insulation resistance tests on the controller and operating circuits (AC-24V circuits).

2) Do not make short circuit between terminals. Those stated in 1) and 2) may cause controller damage.

**8. Inspection method**

**1) Checking thermostat step relay**

Check the thermostat step relay while depressing the relay (step) check button. Refer to item 2-7).

**a. Frozen mode**

- Set the digital temperature display switch to "RETURN AIR".
- Keep the relay check button depressed.
- Temperature setting is fixed at  $-18^{\circ}\text{C}$  and the inside temperature will falsely swing for  $0.1^{\circ}\text{C}/\text{sec}$ . from  $-15.5^{\circ}\text{C} \rightarrow -20.5^{\circ}\text{C} \rightarrow -15.5^{\circ}\text{C} \rightarrow$ , all of which are indicated on the digital display.
- With the temperature setting at  $-18^{\circ}\text{C}$  the step relay of thermostat is turned on and off in accordance with such temperature fluctuation (which is confirmed by LED lamp). The temperature displayed digitally at this time is the function point of the relay.
- Release the relay check button, and the operation becomes normal.

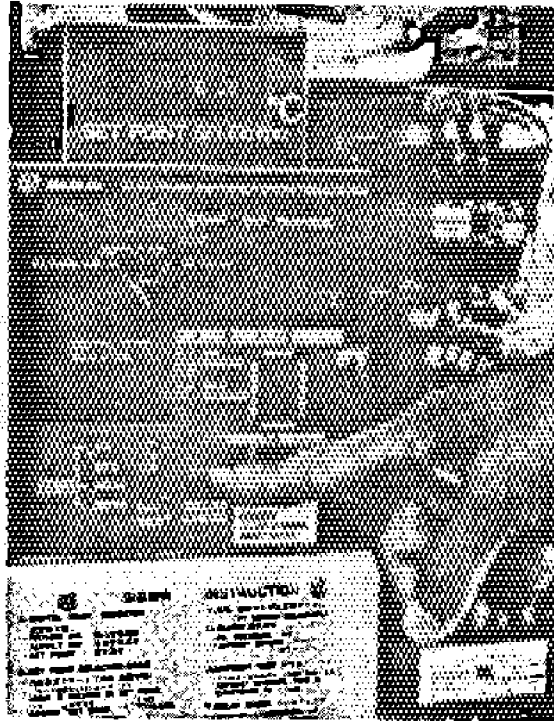

**b. Chilled mode**

- Set the digital temperature indication switch to "SUPPLY AIR".
- Press the relay check button, and the temperature setting is fixed at  $0^{\circ}\text{C}$  causing the inside temperature to swing falsely from  $+2.5^{\circ}\text{C} \rightarrow 0^{\circ}\text{C} \rightarrow -2.5^{\circ}\text{C} \rightarrow$ .
- Set the temperature at  $0^{\circ}\text{C}$  and check the relay function point in the same way as the FROZEN mode.
- c. Refer to the Function Pattern Table of item 6 for relay function points.

**2) Defrost test**

Press "DEF.TEST" button for testing. (Press the button once, and release it.)

--- Refer to item 2-5).

- a. The test lamp (red) lights after pressing the button and the timer starts counting.

Within In range (IRS : ON)	} Defrost starts.
... after 43 sec.	
Outside In range (IRS : OFF)	}
... after 14 sec.	

**b. Starting of defrost**

After the timer finishes counting

DEF. lamp (red) lights	} Compressor stops pumping-down.	} HSS1, HSS2 are turned ON.
MSS1, MSS2 : OFF		

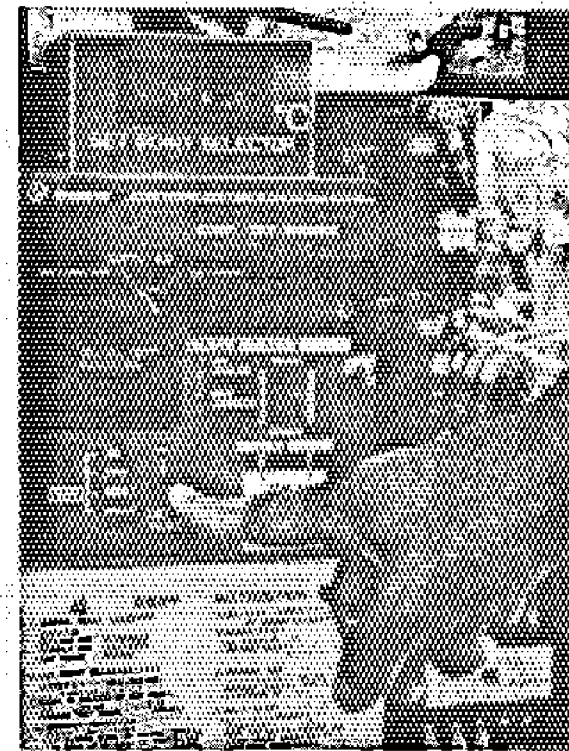

- Notes
1. This test cannot be effected during defrosting and at the failure of sensors.
  2. Defrosting does not continue when the defrost thermistor is OFF (above  $+40.6^{\circ}\text{C}$ )
  3. When the defrost thermistor is faulty (short circuit or disconnection)
    - Either connect between terminal No. 7 and 8 of the terminal PCB (PCB-6) or remove the wire connections for the terminal No. 7. or 8. This lights the ALARM pilot lamp (red) of DEF. SENSOR.
    - Press the manual defrost button under the above conditions to test defrosting according to the back up function (item 3-3).



**3) Back-up test of sensor (Pt)**

- a . Either connect wirings of return air sensor or supply air sensor (between terminal No. 1 and 2 or No. 4 and 5 of the terminal PCB) or remove the wire connections for terminal No. 1 or 2 and No. 4 or 5.
- b . Checking faulty display
  - Confirm if the digital display shows, the faulty condition of the control sensor.  
Refer to item 2-4)-(c).
  - Confirm if "E" is shown on the digital display.  
Refer to item 2-2).

**4) Checking of oil pressure protecting**

- Connect between terminal No. 13 and 17 of the terminal PCB.
- Start the compressor. Oil pressure protecting functions after 110 seconds to stop the compressor (CS and COMP. LED : OFF) and the OIL PRESS. ALARM pilot lamp (red) goes on simultaneously.
- Reset check  
Turn on the oil pressure reset switch (in the control box cover) within 120 seconds after the compressor stopped. The ALARM pilot lamp flickers.  
-- This restarts the compressor 120 seconds after it has stopped, and the ALARM pilot lamp goes off.

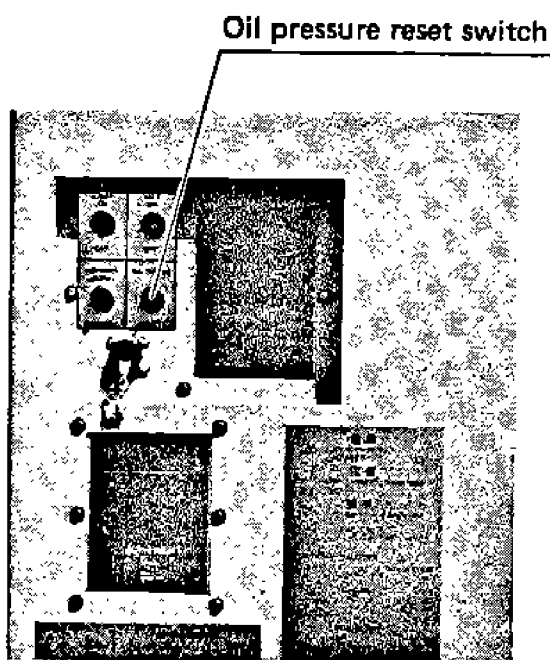

Oil pressure alarm lamp (Red)

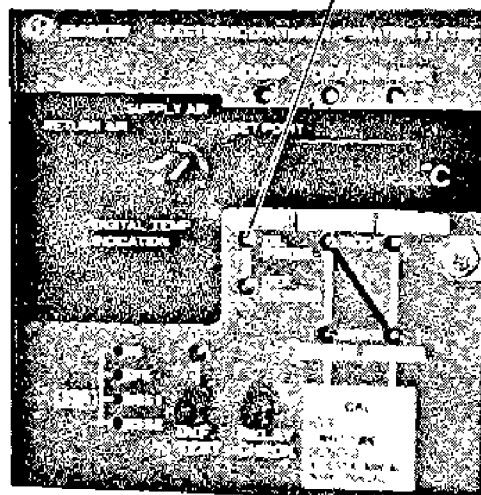

**5) Checking the voltage of the modulating valve (MV)**

- Set the temperature at  $-5^{\circ}\text{C}$  or above (CHILLED MODE).
- Measure the voltage (DC) between terminal No. 19 - 20 of the terminal PCB when the temperature is within In range against the temperature setting, and confirm if the voltage of the modulating valve is within the range of 0~20 volts.
- The modulating valve voltage should be 0 volt when the temperature setting is outside the In range, or in FROZEN mode or DEFROST mode.
- Coil check  
Remove the wire connections for the terminal No. 19, 20 of the terminal PCB and measure the coil resistance of the valve terminal.  
→ Approx. 18 Ohm (at  $25^{\circ}\text{C}$ )

**9. Troubles of controller**

**1) Phenomena**

When a controller is out of order, replace it with a new one.

Note) Confirm if the sensor (Pt) and thermistor are functioning normally.

- Remove the wire connections from the controller terminal PCB and measure the resistance between the terminals. (Refer to the temperature vs resistance characteristics table of item 11)
- a . Digital display and controller do not function when the power is on.
  - Check if the voltage (between terminal PCB No. 17 - 18) is AC24V.
  - Check if the external wiring (item 7-2)) is normal.
  - Check if the connector wirings between each PCB are well fixed.
- b . LED does not light with the normal load (solenoid valve, relay, etc.) → Is lamp switch (3-30L : Control box cover) turned ON?
- c . Sensor (Pt) is normal, but output function is abnormal.
- d . Sensor (Pt) is normal, but "E" is displayed and LED display of the sensor goes out.
- e . DEF sensor ALARM is displayed when the defrost termination thermistor is normal.
- f . The load does not function with LED displaying.
- g . Voltage (MV) to modulating valve (20M) is not applied by operating within In range of CHILLED mode).
- h . The controller does not function according to external input (pressure switch, control switch).
- i . Temperature setting can not be changed by turning the set point selector (digital temperature display switch should be at "SET POINT" position).
- j . Controller's functions are not normal.

2) Replacemet procedures for controller and printed circuit board.

1) Steps

1. Shut off power supply
2. Remove terminal cover (set screws×3)
3. Remove terminal board assembly (set screws×4)

**Pull-out connectors**

- Slowly pull out terminal board assembly.
- Remove connectors between printed circuit board and controller.

Note: Don't pull the lead wire itself.

4. Remove controller from control box.

- fixed at two locations at bottom front
- fixed at two locations at inside top
- fixed at one location on left side top

5. Replace part in question by referring to the Figure below.

6. For reassembly, reverse the above steps while confirming that connectors are fully inserted.

Note: When re-inserting connector, match guide direction, number of pins and connector numbers.

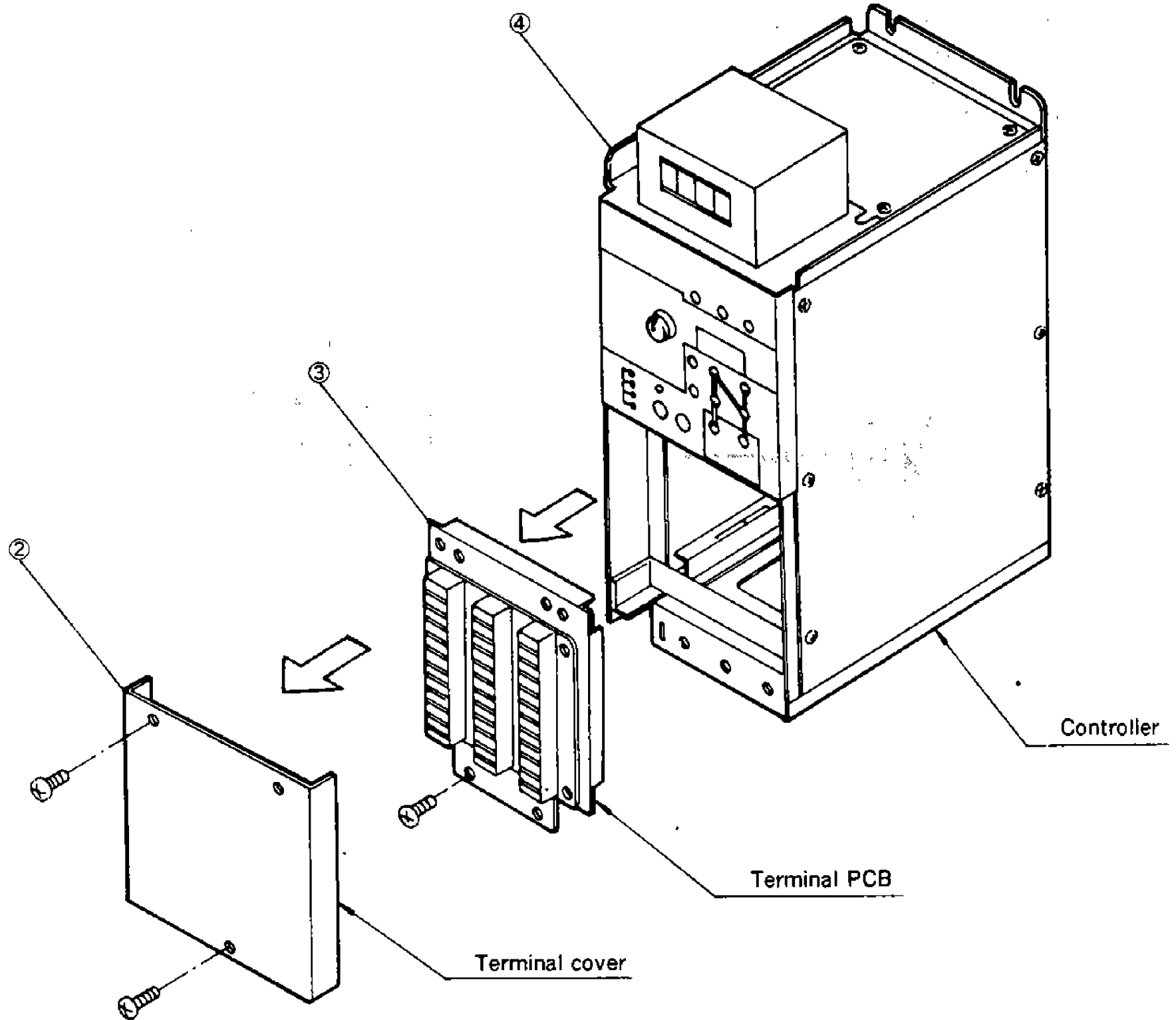

**10. Operation for emergency**

1) Procedures described below are for forced operation in an emergency when a new controller is not available although the controller has been found faulty. Since the defrost system, oil pressure switch, etc. may not function properly sometimes depending on the nature of the controller fault, check this operation after modification.

The controller must be replaced immediately when new one is available.

2) FROZEN mode operation (continuous operation of evaporator fan and compressor)

a. Remove the connectors (CN6B to E : 4pcs. in total) of the controller terminal PCB (reverse side). Refer to 2) in item 9 for the details.

b. Additionally connect short circuit lines (three block lines shown at below) to the terminal PCB.

c. Continuous operation is possible after the above procedures have been completed.

Note Protection switches (63HL, 51C, 49) may function to temporarily suspend compressor operation in this mode.

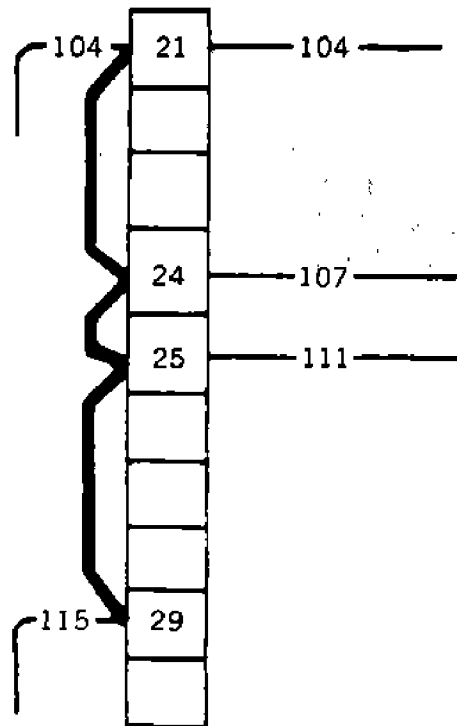

Terminal board on the terminal PCB

**3) Heater operation**

Note Over-heat prevention thermostat may not function due to controller problems during heater operation, causing over-heating.

Take care to prevent over-heating.

a. Defrost operation

(Supply power to heaters H1~H8.)

- Remove the connector from terminal PCB as described in item 2).
- Additionally connect short circuit lines (two block lines A and B shown at below) to the terminal PCB.

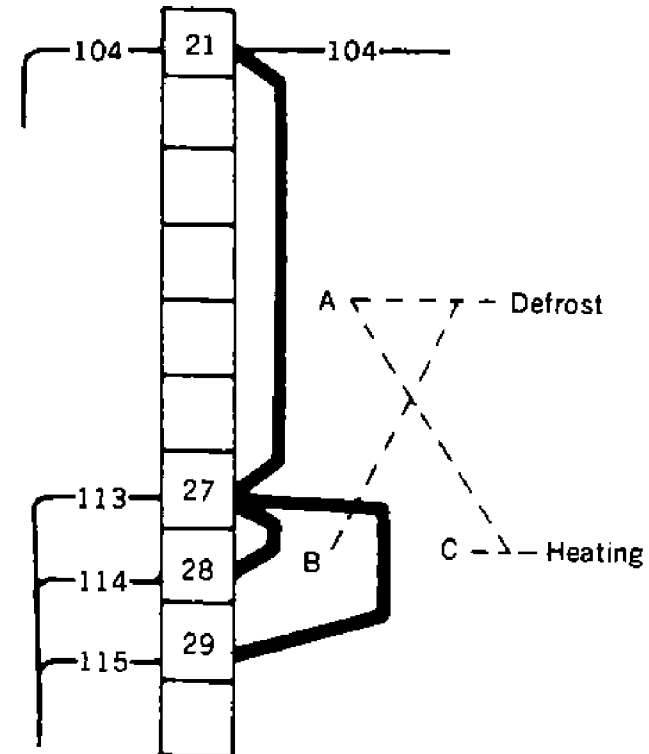

**IMPORTANT :**

To terminate defrosting, the power must be manually turned OFF or the short circuit lines removed.

- b. Heater operation (continuous operation of heaters H1,H2,and evaporator fan)
  - Change the short circuit lines from A.B to A.C for the defrost operation in item a.
  - To stop heater operation, the power must be manually turned OFF or the short circuit lines removed.

11. Sensor characteristics (temperature vs resistance characteristics)

Control sensor (platinum resistance thermometer element: S.S, R.S)  
Temperature vs resistance characteristics  
Rating:  $100\Omega \pm 0.3\%$  ( $0^\circ\text{C}$ )

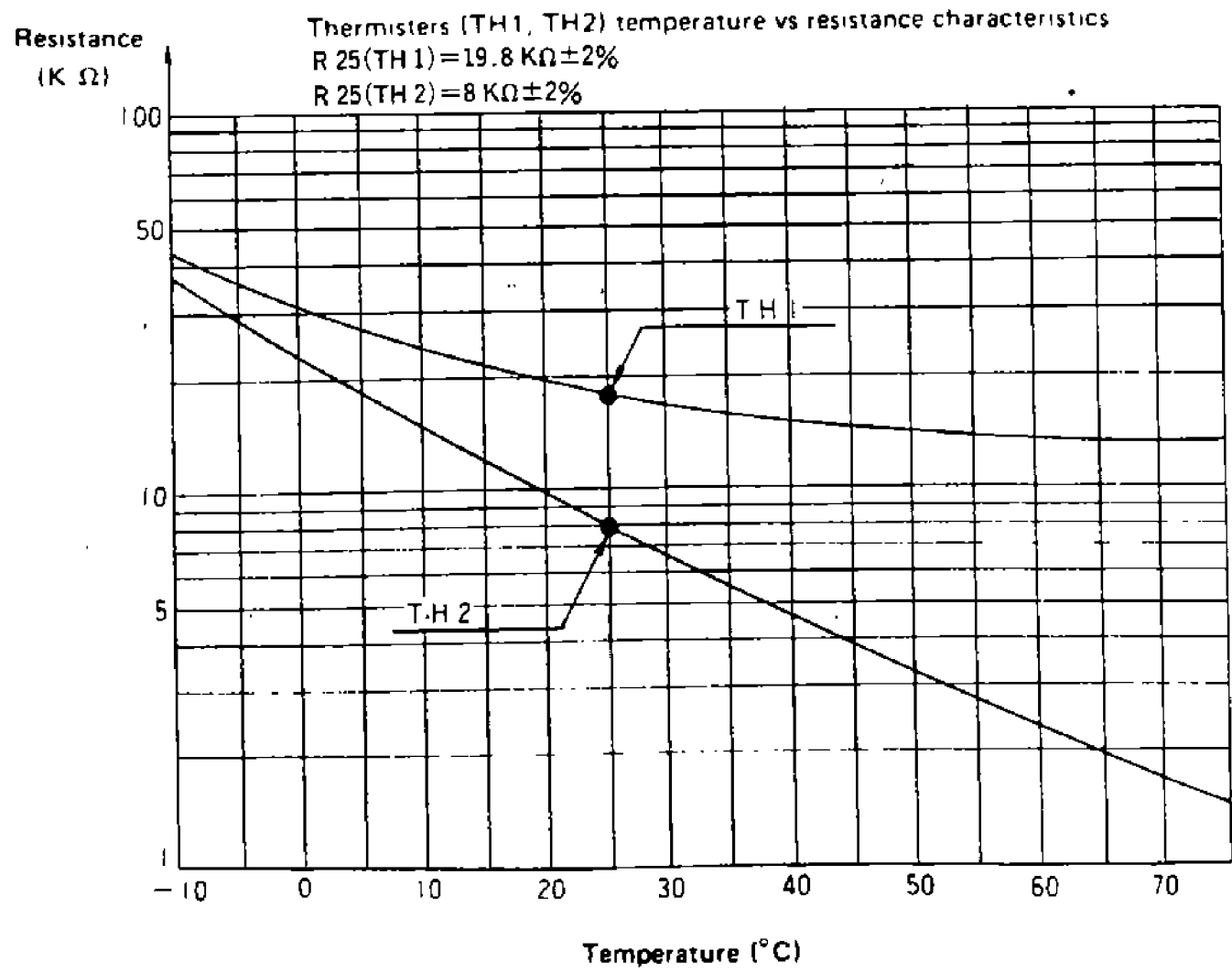
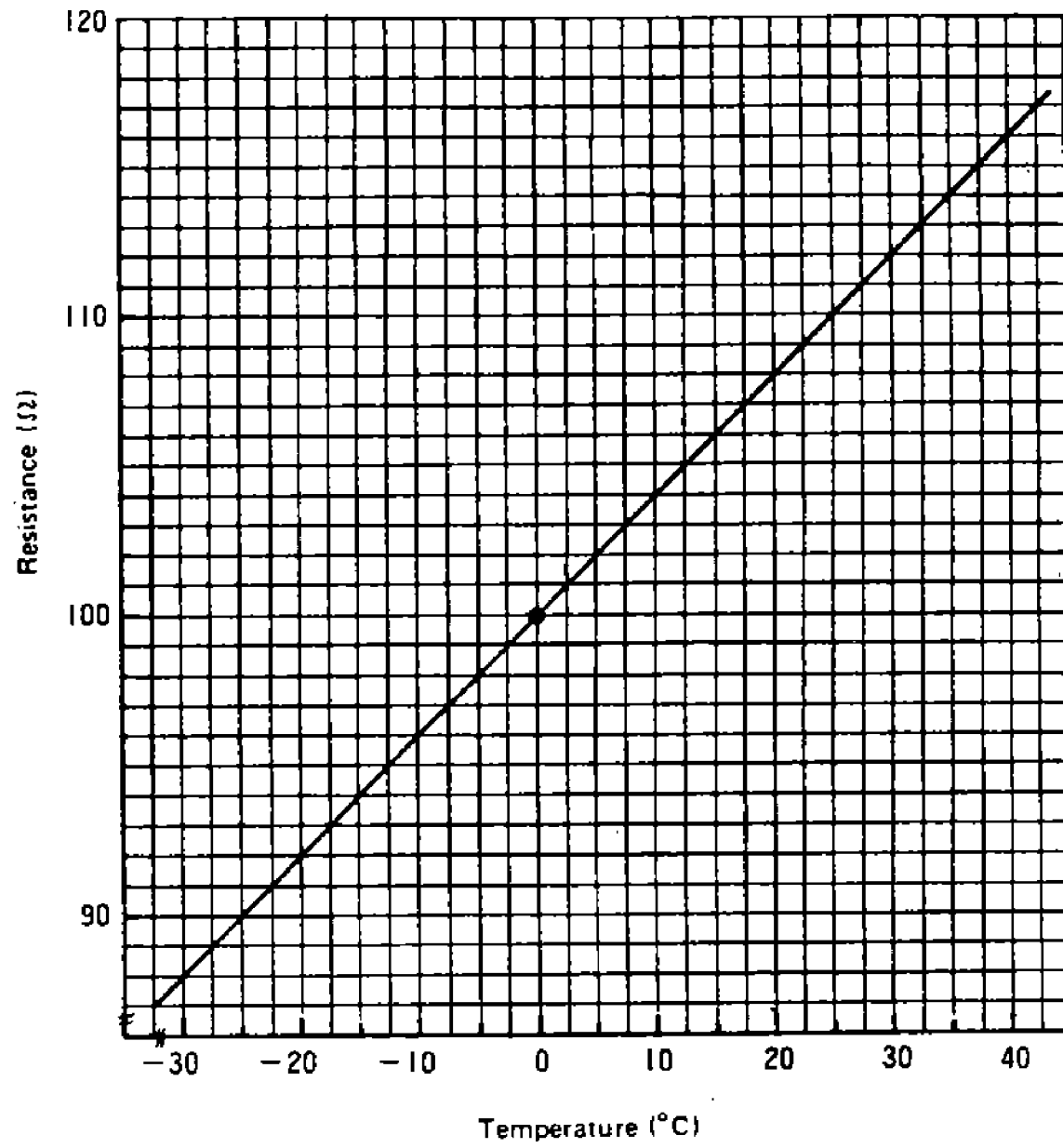

#### 4.3.2 Modulating control valve (20M)

- a . An electromagnetic modulation valve is proportionally operated by the output voltage from the controller. It continuously adjusts the hot gas bypass volume and controls the supply air temperature during the chilled mode.
- b . Valve position
  - When a current is not input, when in the frozen mode, and during pump down stop ... closed
  - Coil resistance  $18\Omega$  (25°C)

Modulating control valve

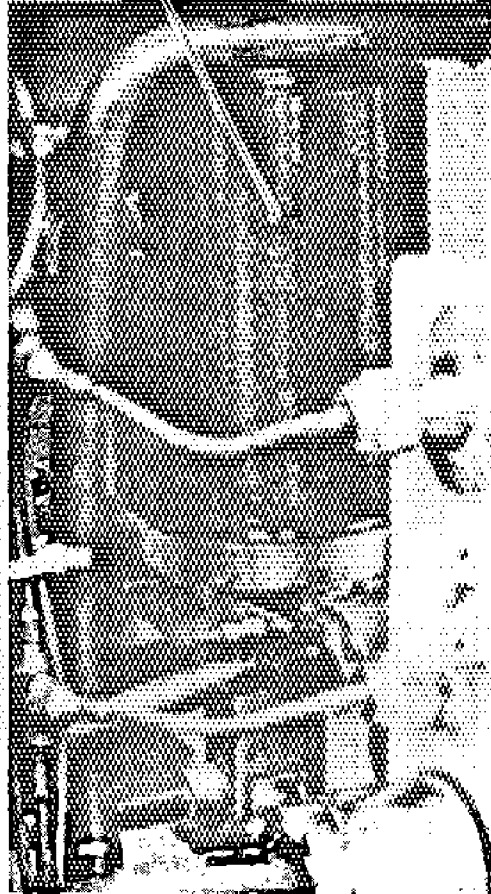

4.3.3 Recorder

1. Specifications

- Model SKM-2924A
- Feeler tube Gas sealed
- Recording method Pressure sensing type
- Recording temperature range  $-29.9 \sim +25^{\circ}\text{C}$  ( $-22 \sim 77^{\circ}\text{F}$ )
- Recording paper Dia. 203 Disk type pressure sensible paper (Graduation  $1/1^{\circ}\text{C}$ )  
(Corresponding to PSD-217C (REV. A) made by PARTLOW Co.)
- Driving method for recording paper Timer (Quartz motor + reducing gears) a turn/31 days

Quartz motor driving source:

Goods corresponding to Dry battery  
(DC 1.5V) JIS C 8501 .....SUM2  
IEC .....R14

Life is approx. 1 year (Remaining voltage indicator)

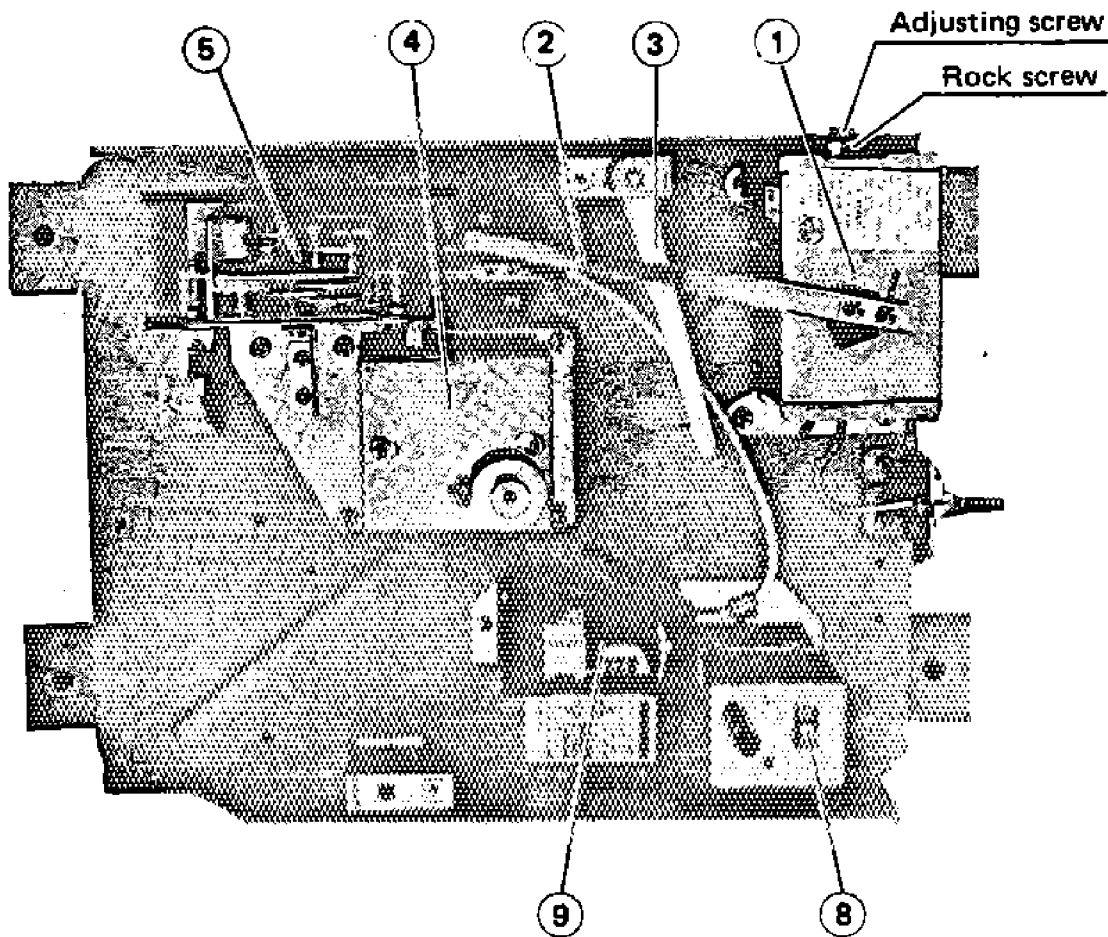
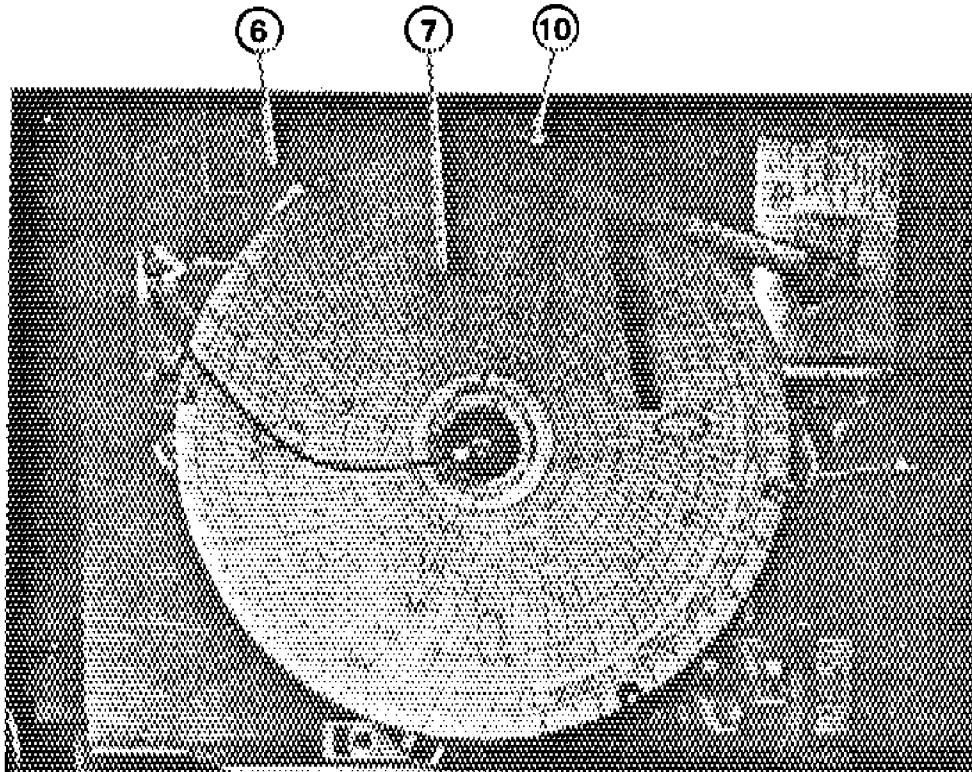

- ① Element
- ② Pen
- ③ Pen lifting arm
- ④ Reducer
- ⑤ Quartz motor
- ⑥ Recording board
- ⑦ Recording paper
- ⑧ Remaining V indicator
- ⑨ Battery
- ⑩ Present time plate

**2. Inspection of recorded temperature**

Recording pen on chilled mode

Operate the unit in chilled mode at 0°C setting and confirm with the digital temperature display of the controller that the supply air temperature has stabilized at 0°C. Then rotate the digital temp. indication switch to return air and calibrate the recording pen according to the return air temperature on digital display.

**3. Adjustments**

1) Make adjustments subsequent to the inspection in item (2).

2) Turn the temperature setting screw (A) to adjust the temperature. Loosen the lock screw (B) and turn the setting screw (A) clockwise to temporarily raise the temperature setting by approximately 5°C.

Then turn the setting screw (A) counterclockwise to lower the temperature setting of the pen until the temperature is adjusted to 0°C or -18°C.

Tighten the lock screw (B) after the adjustment.

Note 1 One turn of the setting screw (A) changes the temperature setting by approx. 5°C (9°F).

2 Be careful that the temperature setting may be altered by tightening the lock screw (B).

3) Generally a temperature recorder should be adjusted at 0°C, but the following method is available when the setting temperature is known.

- Chilled mode (Setting temperature above -5°C)  
..... "Adjust at 0°C."
- Frozen mode (Setting temperature below -5°C)  
..... "Adjust at -18°C."

**4) Inspection and adjusting method**

1. Adjust a temperature recorder when the container inside temperature becomes decreasing.

Temperature recorder's pen shows the temperature correctly when it is decreasing.

Don't adjust it when the temperature become increasing.

It is caused from its hysteresis that a pen sometimes shows the temperature lower from 1°C to 3°C when the temperature is increasing.

2. It is a normal phenomena that the recording curves are a little influenced by the fluctuations of the ambient temperature. (Note : Basically the temperature recorder is designed for 25°C ambient, and 10°C fluctuations of the ambient temperature cause the error of ±0.2°C.)

3. A temperature recorder adjusted at 0°C sometimes shows the following curves at -18°C inside. It is a normal and allowable range.

If the range exceeds the above, readjust it at 0 °C (or -18°C).

4. Don't move the pen by hand, because it will cause an increase of error.

5. When the pen is held by the pen lifter the pen may move unsmoothly, but it is no problem.

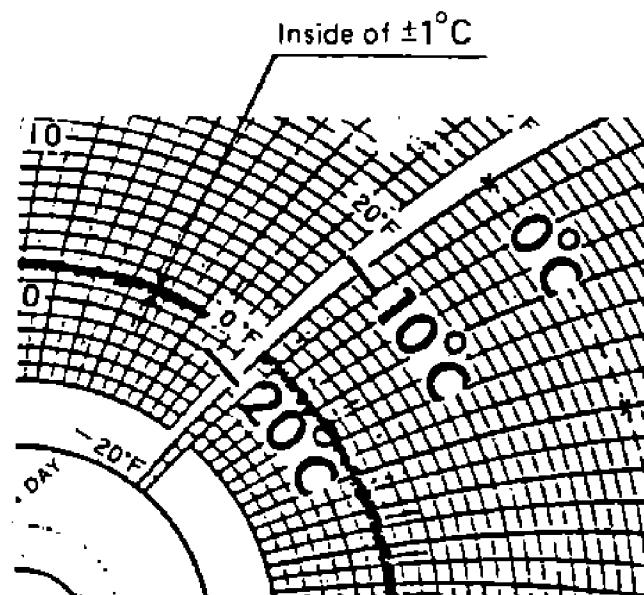
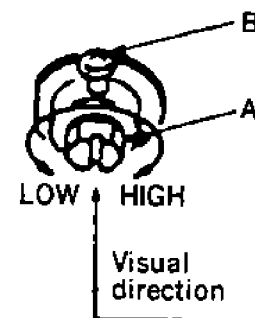

4. Replacement of parts

1) Battery

a) Replacement interval

- When the indicator is out side the blue zone after checking the residual voltage of the battery. (When the indicator is above the dotted lines, i.e., within the white zone shown in the right figure, the battery has approximately one-month life.)

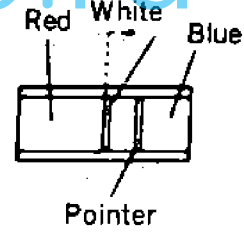

Residual voltage indicator

b) Replacement method

- Remove the recording panel and insert the new battery making certain that the battery polarity is correct. Use SUM-2 of JIS C8501 or IEC R14 battery or the equivalent (DC1.5V dry cell).
- After replacement, confirm that the pointer of the residual voltage indicator is within the blue zone and that the quartz motor functions properly.

2) Residual voltage indicator battery

a) Replacement interval

- In case oscillation of the needle is unstable when the push switch is pressed down for confirmation of remaining voltage.
- In case the remaining voltage indicator needle is within the white zone or in the red zone, although a new battery is set in.

b) Replacement method

- Remove the recording panel by loosening the screw.
- Remove the residual voltage indicator battery from the body, and replace it with a new one.
- When replacing the battery make certain that the terminal wirings are connected red to red and black to black
- After replacement confirm that the pointer is within the blue zone and that the quartz motor functions properly.
- Battery is to be replaced every 12 months.

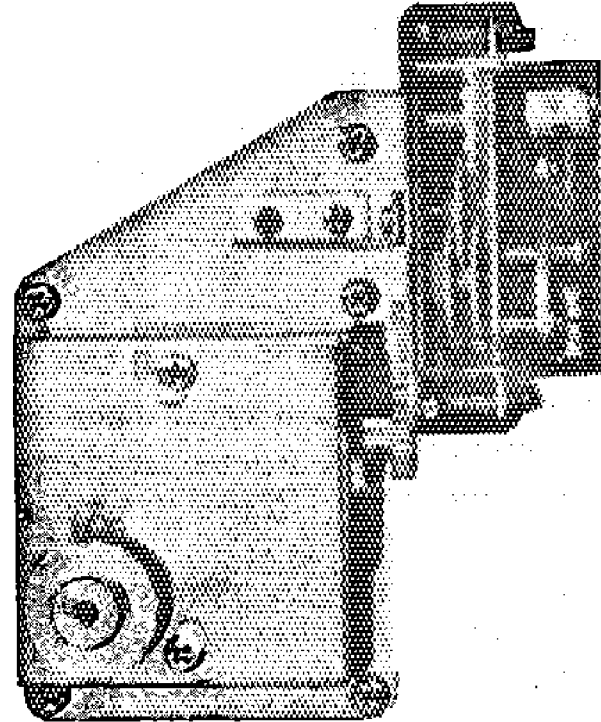

Timer (quartz motor speed reducer) (WKM-AA012)

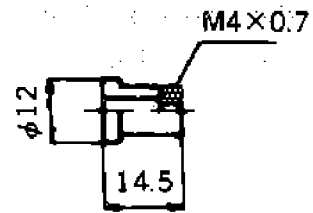

Accessory (anti-vibration rubber : 5 pcs)

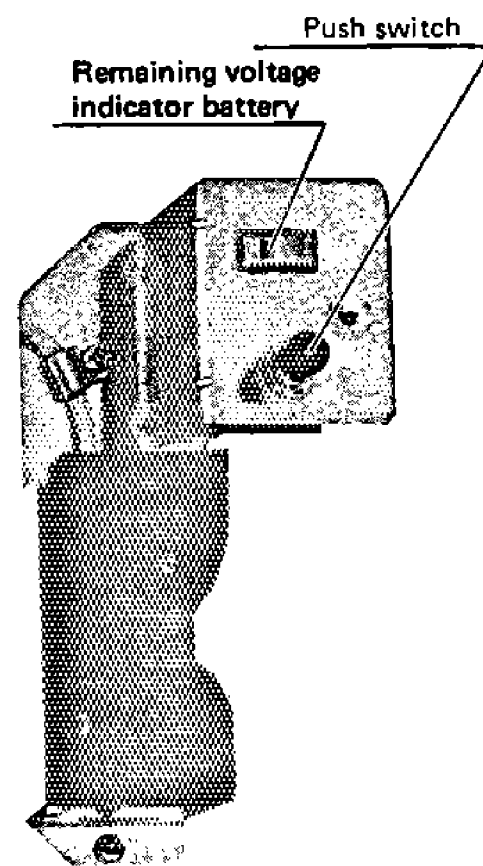

Residual Voltage indicator battery (DKM-AA003)



3) Timer (quartz motor speed reducing gear)

a) Replacement interval

- When the quartz motor does not function even though residual voltage battery is normal.
- When the timer delays over three hours a day.

b) Replacement method

- Remove the recording panel to remove the wiring. Loosen the screws (5 pcs) to remove the timer, and replace the timer with a new one.
- When replacing the timer, also replace the antivibration rubbers (5 pcs). The red wire is for (+) and the black wire for (-), therefore, connect the red terminal with red and the black with black. Tighten the anti-vibration rubbers with torque of 4 ~5kg-cm.
- Confirm that the quartz motor functions correctly after replacement.

4) Thermal feeler bulb

a) Replacement interval

- After the pen has been adjusted and the controller has been operated within the temperature range of -18 to +10°C (-0.4 to 50°F), with the inside temperature stabilized at the temperature setting: When the temperature indication under the above conditions deviates by more than 2°C (4°F) against the temperature setting. (When the temperature indication is substantially less than the temperature of the thermal feeler bulb, gas leakage may be suspected.)

b) Replacement method

- Loosen the screw and remove the thermal feeler bulb - element. Replace it with a new one.
- After replacement, inspect and adjust.

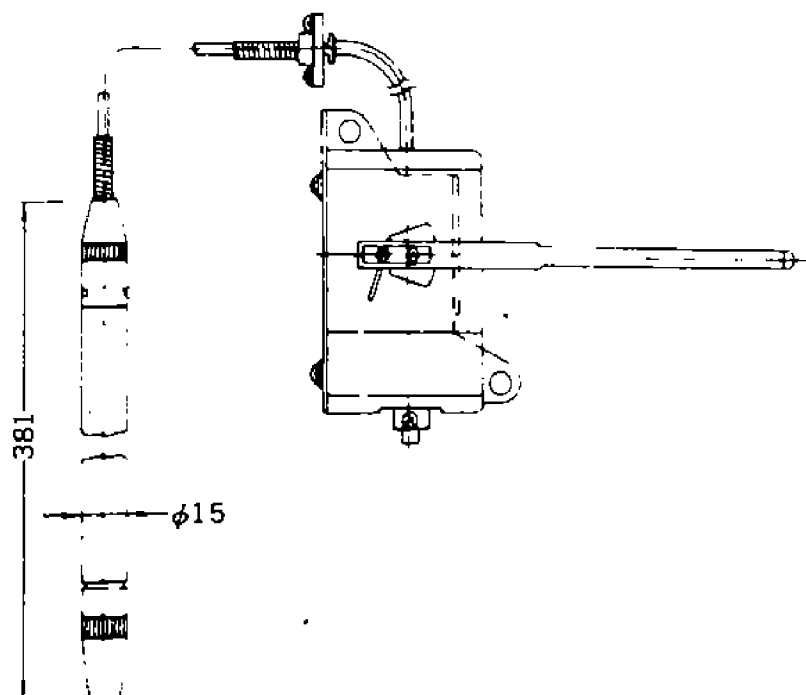

Thermal feeler bulb - element . . . . . (SKM-AA001)

**4.4 Description on electrical and functional parts.**

**4.4.1 Dual pressure switch (63HL)**

This stops the compressor when the pressure has risen or fallen excessively in the unit. The high pressure may rise above preset of HP if the condenser fan fails or cooling water does not circulate properly, etc. The low pressure may fall below preset of LP if "pump down" has been performed because the refrigeration circuit is blocked or the solenoid valves are closed. In these cases, the switch stops compressor.

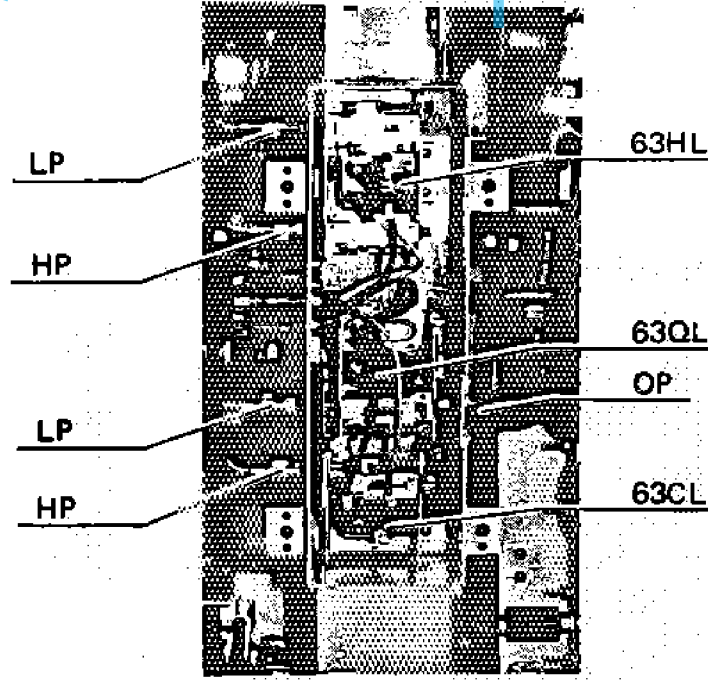

LP : Low pressure  
 HP : High pressure  
 OP : Oil pressure

Pressure switch box

(a) Adjustment method

Adjust the switch by turning the adjusting screw as described below;

Adjusting points of dual pressure switch

	Adjusting screw	Rotary direction		Function
High pressure side	Setting of adjusting screw	Clockwise		Setting (OFF value) becomes high, and pressure at the stopping of the refrigeration unit becomes high.
		Counter-clockwise		Setting (OFF value) becomes low, and pressure at the stopping of the refrigeration unit becomes low.
Low pressure side	Setting of adjusting screw	Clockwise		Setting (ON value) becomes low, and pressure at the starting of the refrigeration unit becomes low.
		Counter-clockwise		Setting (ON value) becomes high, and pressure at the starting of the refrigeration unit becomes high.
	Setting of adjusting screw for differential	Clockwise		Pressure difference between ON and OFF becomes large and difference between pressure on the starting and on the stopping becomes large.
		Counter-clockwise		Pressure difference between ON and OFF becomes closer and difference between pressure on the starting and on the stopping becomes closer.

- Notes:**
- 1) If it is necessary to adjust the adjusting screw for differential, be sure to adjust pressure setting first and then adjust differential.
  - 2) After adjusting the adjusting screw, apply anti-loosening to the bolt head to prevent the bolt from being loosened vibration.

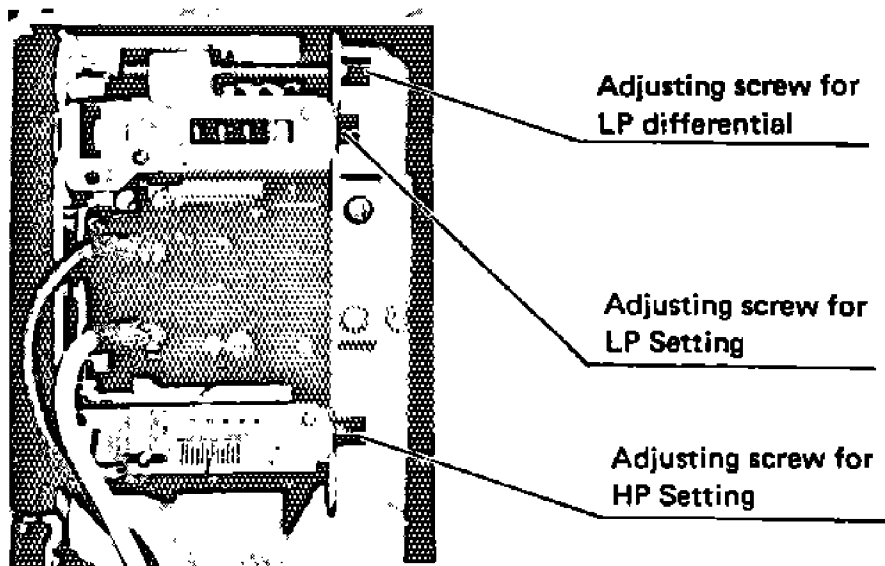

**4.4.2 High pressure control pressure switch (63CL)**

If the ambient temperature is low during air cooled operation, one out of three condenser fans is turned off so that the high pressure should not fall. (As for more details, refer to "high pressure control")

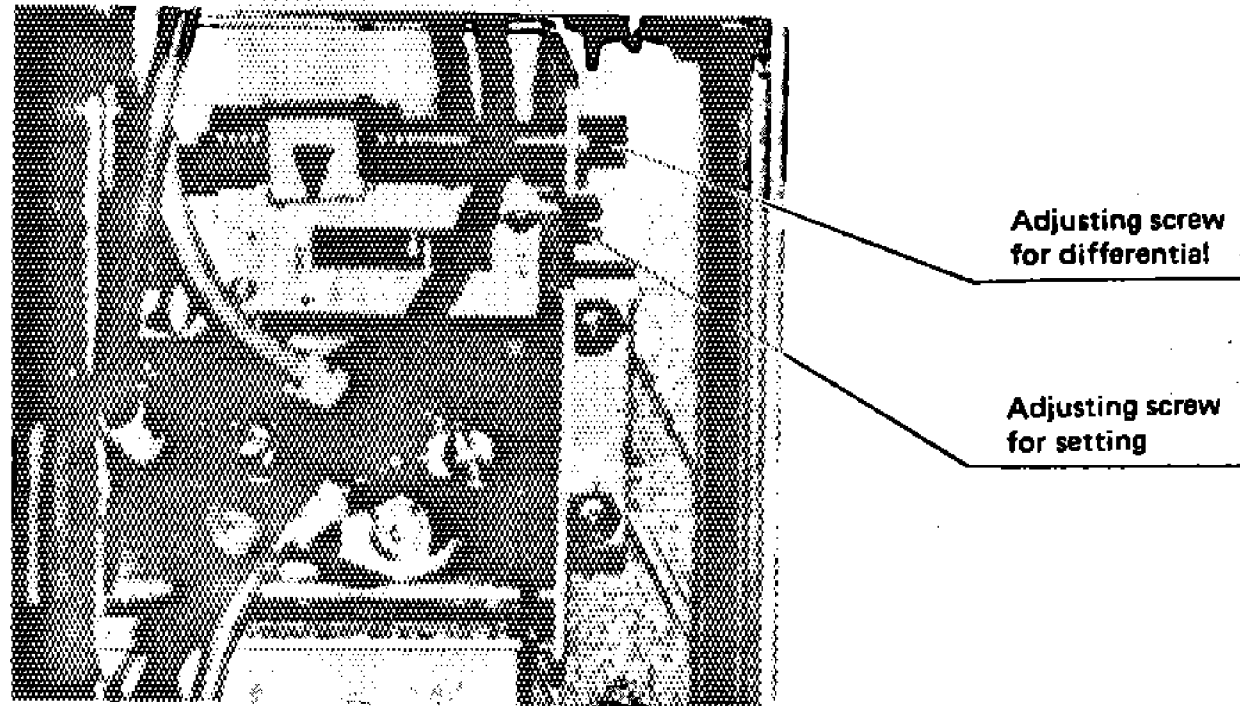

- (a) Adjusting method  
Adjust the adjusting screw as staged below.

Adjusting points for high pressure control switch

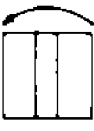
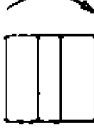
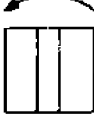
Adjusting screw	Turning direction	Function
Adjusting screw for setting	Clockwise 	Setting value (OFF value) becomes low and a fan out of three stops at lower ambient.
	Counter-clockwise 	Setting value (OFF value) becomes high and a fan out of three stops at higher ambient.
Adjusting screw for differential	Clockwise 	Pressure difference between ON and OFF becomes large and stopping period of certain fans is prolonged.
	Counter-clockwise 	Pressure difference between ON and OFF becomes small, and stopping period of certain fans is shortened.

- Notes:**
- 1) In case it is necessary to adjust the adjusting screw for differential, be sure to adjust setting first and then differential.
  - 2) After adjustment of the adjusting screws, be sure to apply anti-loosening to the bolt heads to prevent them from loosening by vibration.

**4.4.3 Oil pressure switch (63QL)**

When oil pressure continues to drop, this switch sends a warning signal to the controller and stops the compressor automatically.

Oil pressure (difference between oil pressure and low pressure) falls due to oil pump failure, clogging and oil foaming.

The compressor may be burnt because of oil shortage.

**(a) Operation**

When the compressor is started, the oil pressure (differential pressure) rises, and the differential pressure contacts of 63QL are opened. However, if the oil pressure fails to rise for over 110 seconds after starting the compressor, the contacts are closed and the timer operates to stop the compressor.

**(b) Resetting**

When the reset switch on the control box is turned on after 120 seconds from the stopping of the compressor, the compressor starts immediately. If the reset switch is turned on immediately after the stopping, the compressor will start after 120 seconds.

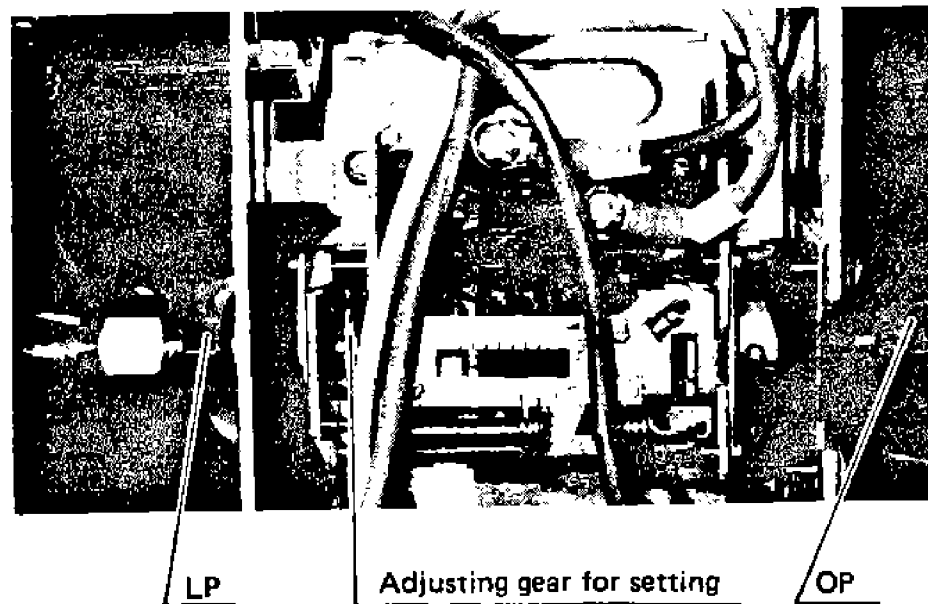

**(c) Adjustment method**

Adjust the oil pressure switch by turning the adjusting gear as described below.



Oil pressure switch

Adjusting points for oil pressure switch

Adjusting gear	Turning direction		Function
Adjusting gear for settings	Clockwise		Functional pressure (differential) becomes low and the differential pressure contact of 63QL is closed with low pressure difference.
	Counter-clockwise		Functional pressure (differential) becomes high and the differential pressure contact of 63QL is closed with high pressure difference.

**Note:** The following turning directions are viewed from the low pressure connection side.

**4.4.4 Water pressure switch (63W)**

This switches over air and water cooled modes. If cooling water flows and water pressure rises above a preset water pressure at the inlet, the contact is turned off to stop the condenser fan motor and water cooled operation will start.

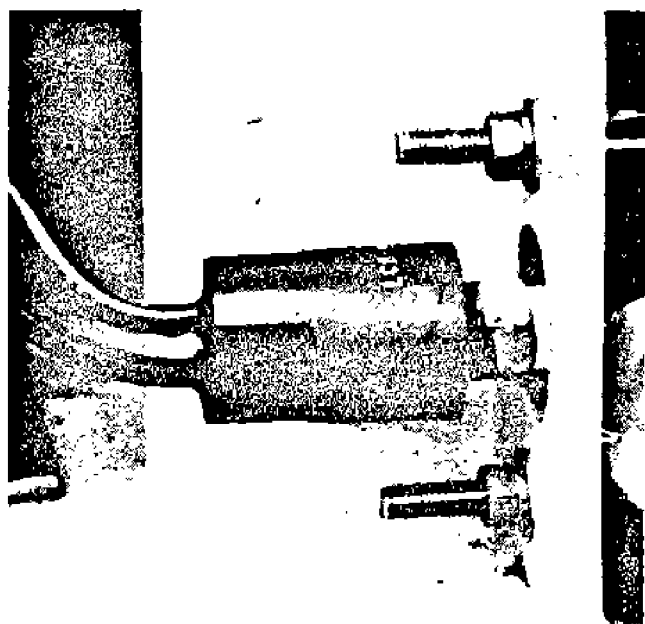

**4.4.5 Defrost thermistor (TH1)**

This senses ambient temperature around the thermistor and detects the defrost termination.

- O F F : 40.6°C
- O N : 23.6°C

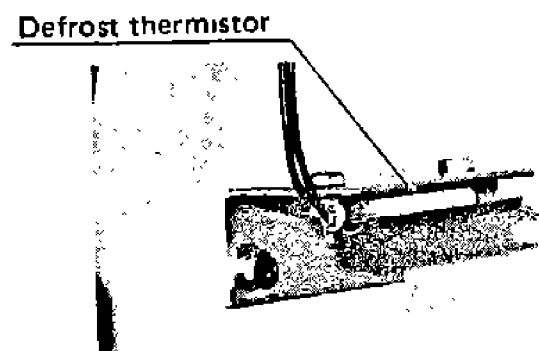

#### 4.4.6 Over-heat thermistor (TH2)

This prevents the electric heaters from over-heating. If the heaters are over-heating, the ambient temperature around the thermistor rises. It detects the over-heat, and the controller cuts off the heaters.

OFF : 71°C  
ON : 49°C

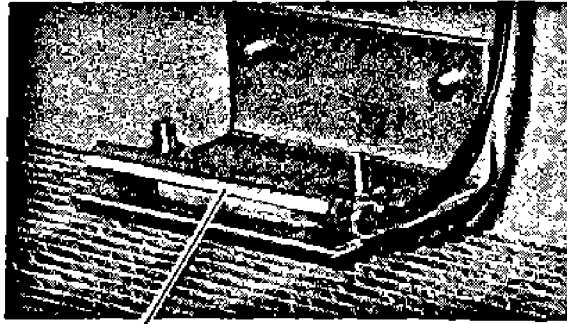

Over-heat thermistor

#### 4.4.7 Electric heaters

Two kinds of electric heaters are used.

##### (a) Sheathed heaters (220V AC, 0.65kW×6)

These are fitted at the bottom of the evaporator. H1 through H6 are used for defrosting. H1 and H2 are used auxiliary heaters during heating operation. To replace them, lift the fittings up and remove them together with the base plate.

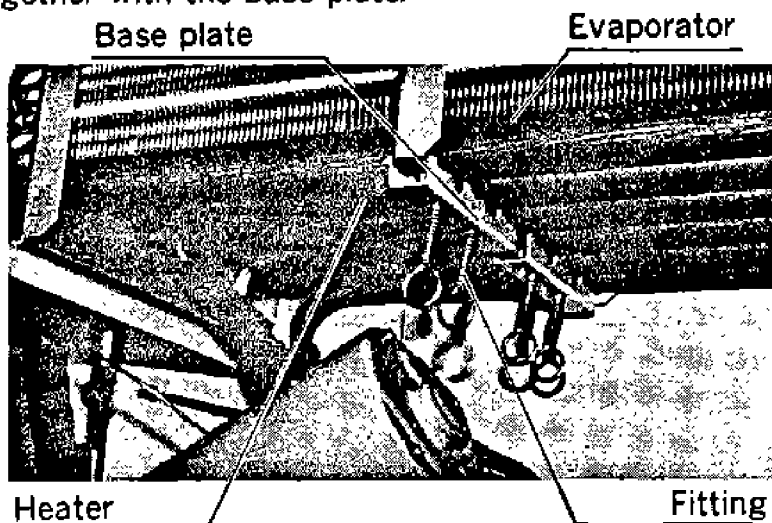

##### (b) Sheathed heaters (AC 220V, 300W×2). These are fitted at the left and right of the drain pan to prevent the drain port from freezing. (H7 and H8)

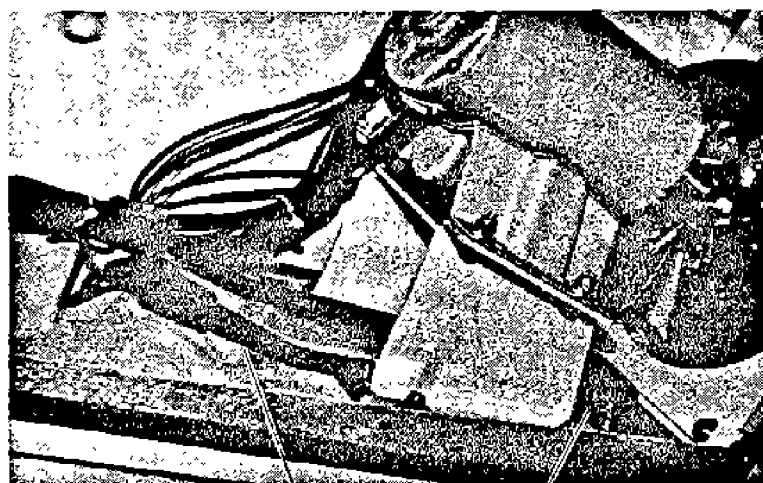

Drain pan heater

Base plate

#### 4.4.8 Air pressure switch (63DA)

If the evaporator is frosted, difference of the air pressure at the inlet and outlet of the evaporator becomes large. If the pressure difference rises above a preset value, the air pressure switch operates and defrosting will start.

##### (a) Checking operating value

- Set the checker device as shown on the right.
- Applying pressure to the high pressure side, lower the test tube slowly. (At this time, small bubbles must come out at the bottom of the tube.)
- Read the length of H (length of the tube which is below the water surface) when the tester indicates continuity. The operating point of the air pressure switch is the value of H plus 5 mmH<sub>2</sub>O. Check this value a few times.
- To apply pressure, you may blow air into the tube. Alternative methods use a pump, APS tester, or manometer.

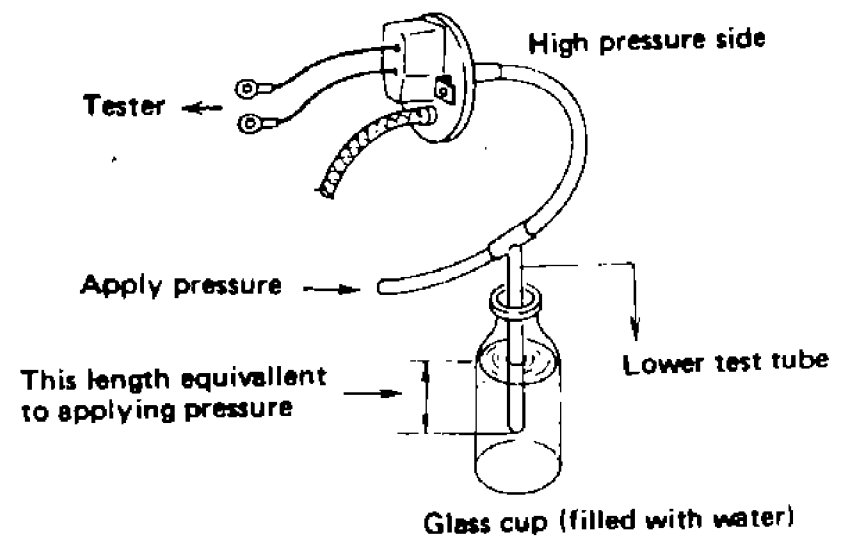
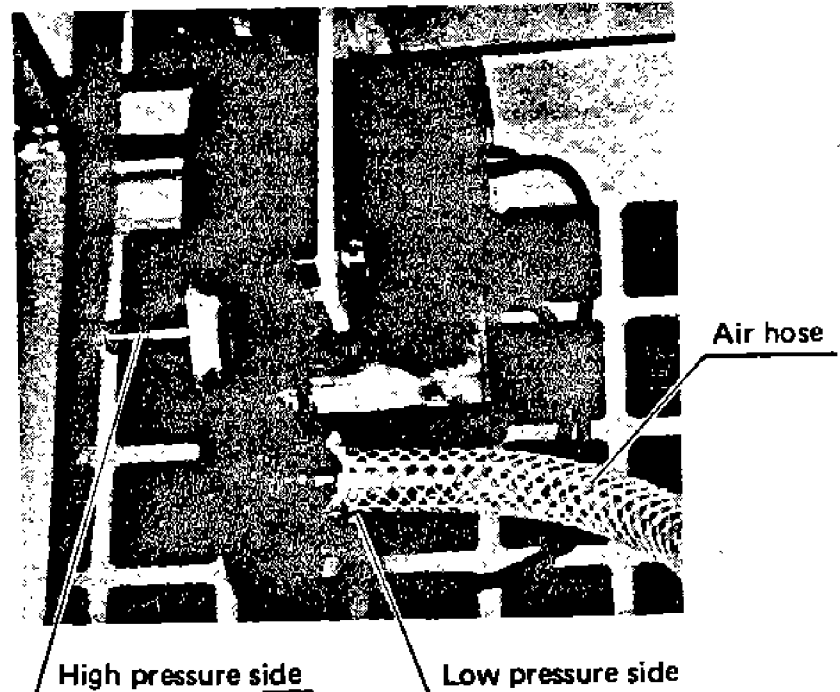

5. Operating pressure and running current

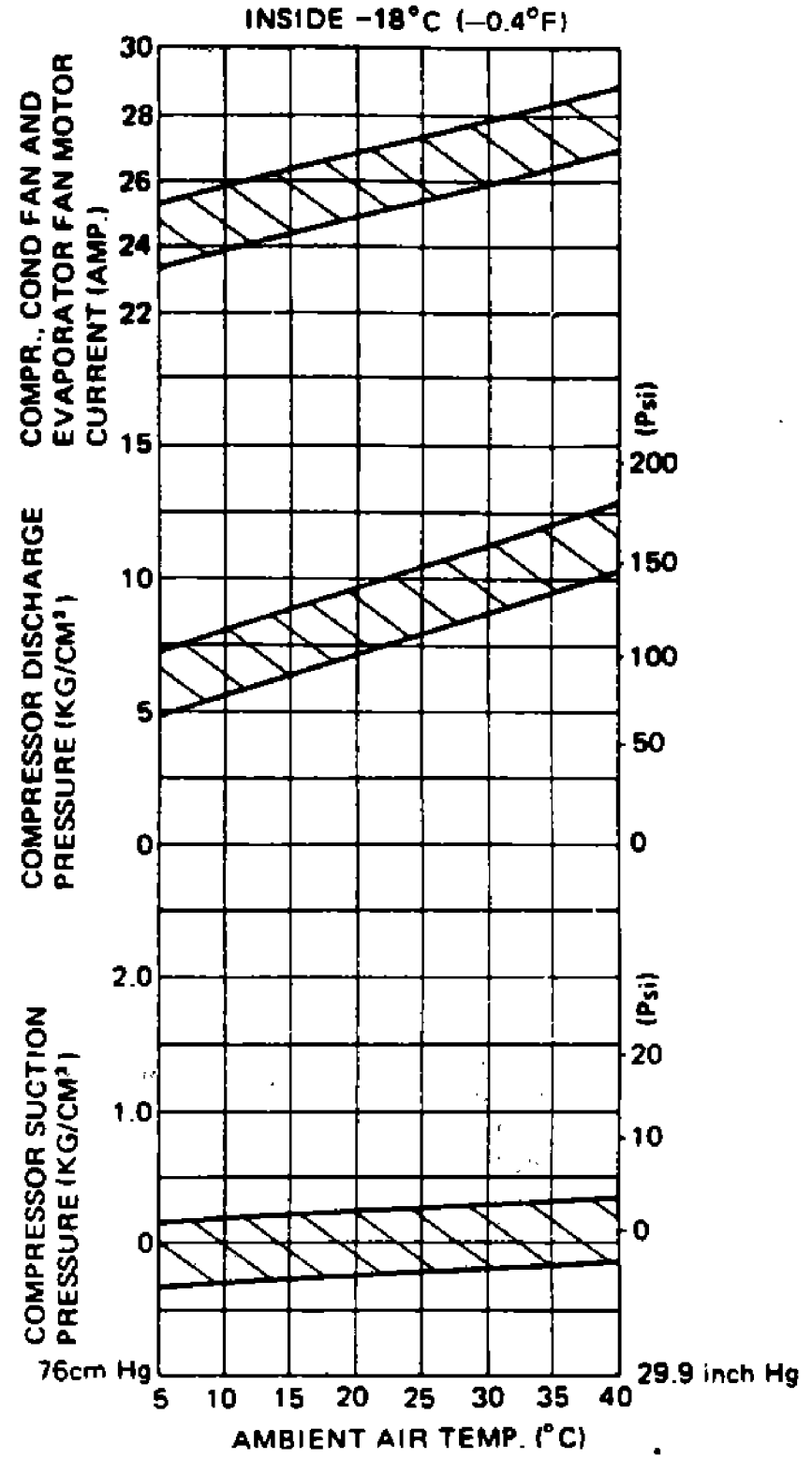
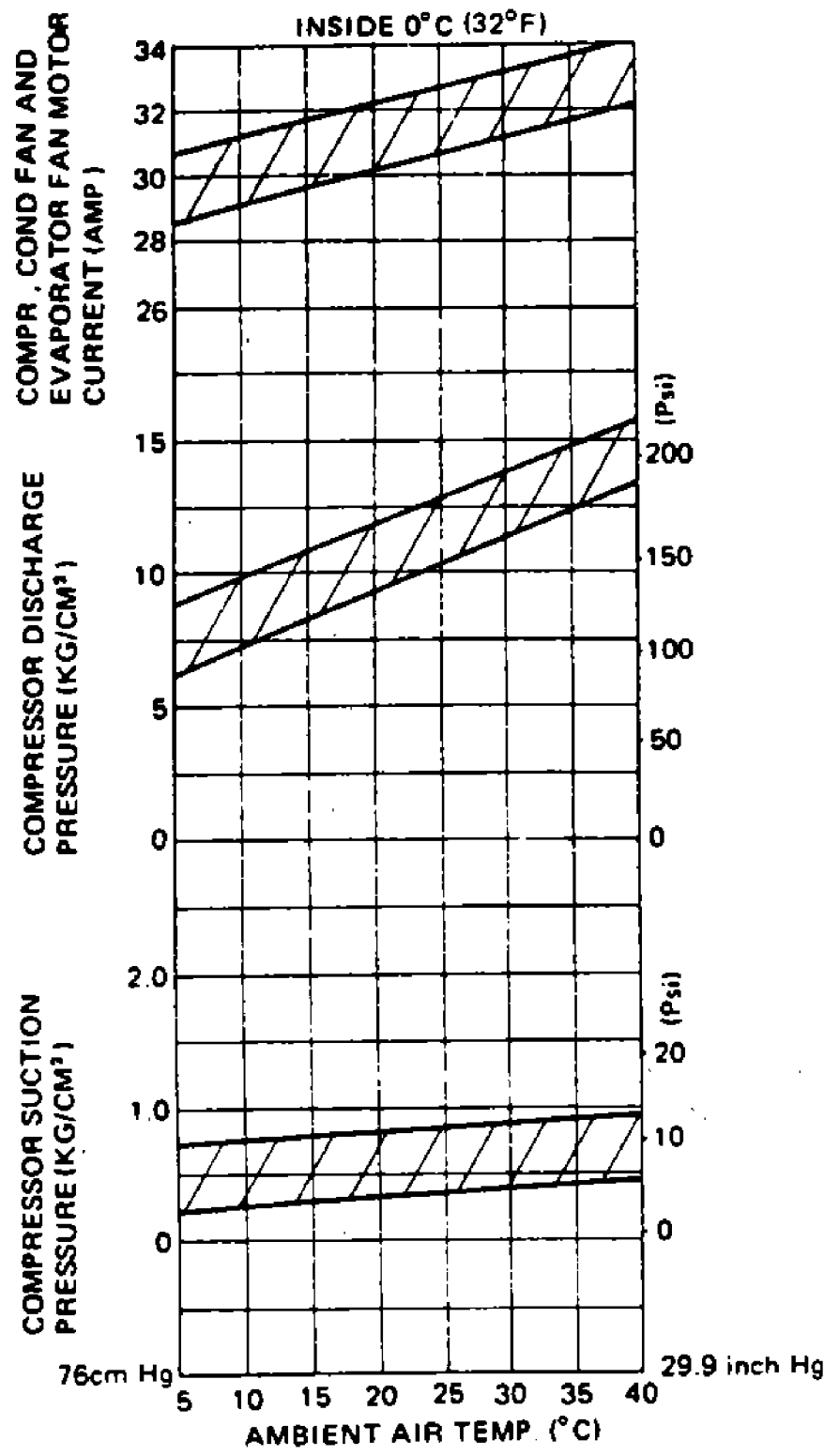

<For reference>

	Item	Unit	Value
1	Heater current—during defrosting measure at primary side of 88H	A	17.0 (AC220V)
2	Running current of condenser fan motor	A	1.2 (AC220V)
3	Running current of evaporator fan motor	A	3.1 (AC220V)
4	Compressor	Kg-cm/lb-ft	435/36
	Compressor stop valve flange (Suction side/Discharge side)		435/36(Suction) 255/21(Discharge)
	Fan motor		125/10
	Solenoid valve		55/4.3
	Expansion valve		250/20.5
	Fan		55/4.3
	Bolt tightening torque		

Note) Allowable range of tightening torque; ±10%.

## 6. Troubles and countermeasures

If the unit does not work properly, inspect it in accordance with "Troubles and countermeasures" to find cause of trouble and repair it.

### Troubles and countermeasures

State	Phenomena	Functioning places	Cause	Countermeasures	
I. Operation inoperative	A : Condenser evaporator fans and compressor are inoperative.	a. No trouble with unit	Current interruption Power source is disconnected.	Trace cause Connect power source plug to power source.	
		b. Circuit breaker function (main circuit)	It functions due to over current.	Trace causes and replace.	
		c. Circuit breaker function (control circuit)	It functions due to over current.	Trace causes and replace.	
	B : Evaporator fans operate but condenser fans and compressor are inoperative.	a. No trouble with unit		The unit halts by function of the temperature recording controller or in heating operation.	
				Set point selector is high	Readjust temp. setting as designed.
		b. Oil pressure control		It is not reset yet.	Repair trouble and turn reset switch to on.
		c. Solenoid valve does not function.		Coil is cut out.	Replace it.
	A : Condenser fans and compressor stop, keeping evaporator fans in operation.	a. Oil pressure switch is functioning.		Oil pressure will not rise. Oil is short or oil pump is out of order.	Additional oil charge, or repair oil pump.
		b. No trouble with unit		Controller functions and stops unit.	
	II. Operation stops soon	B : Condenser fans and compressor operate on and off repeatedly with evaporator fans in operation.	a. Pressure switch functions. High pressure side	Excessive charge of refrigerant.	Discharge refrigerant.
Air in system				Air purge	
Insufficient air flow for air cooled operation.					
Condenser or passage clogged.				Clean or remove obstacles	
Fan blade damaged.				Repair or replace.	
Fan motor does not rotate.					
Capacitor inoperative.				Replace it.	
Fan motor thermostat has functioned.				Trace causes.	
Insufficient water volume for cooling operation.					
Condenser is clogged with scale.					
Lower pressure side			Insufficient refrigerant charge.	Additional charge, seek leaking positions and repair.	
			Dryer clogging	Replace	
			Moisture chokes	Exchange dryer.	
	Gas leakage from feeler tube of expansions valve.	Exchange it.			
b. Over-current relay or compressor protection thermostat has functioned.		Excessive large current due to over-load operation.	Trace causes.		

State	Phenomena	Functioning places	Cause	Countermeasures
III. Inside temp. is low than temperature setting	A : Compressor inoperative.	a. Solenoid valve will not close.	Blocked with dust.	Replace it.
		b. Controller does not function.	Sensor is disconnected	Replace it.
		c. Sensor is installed wrongly.		Reattach it.
	B : Hot gas bypass does not work	Modulating control valve does not open	Blocked with dust Controller is defective	Repair or replace Replace modulating valve or controller
IV. Inside temperature does not drop	A : Inside temperature does not reach to preset temperature (Fans and compressor work)	a. Modulating control valve does not close.		
		b. Capillary tube is defective	Blocked with dust	Repair or replace
V. Inside temperature is not stable	A : Inside temperature is not stable during chilling and heating operations (Fans and compressor work properly)	a. Opening of modulating control valve (valve control voltage) is not stable	Controller is improperly adjusted	Adjust or replace
VI. Heating	A : Heater is inoperative.	a. No trouble with unit	Setting of set point selector is under $-5.0^{\circ}\text{C}$	
		b. Over-heat thermistor	Insufficient evaporator air volume	
VII. Defrosting operation	Defrosting and refrigerating operation are repeated in a short period of time.	a. Defrost timer incorrectly set or faulty.	Improper adjustment	Readjustment



### 7. PTI (Pre Trip Inspection)

To keep the unit in good operating condition, check adjust or repair the unit when necessary. The following is the checking items of PTI (an example of container refrigeration unit checklist).

Container refrigeration unit inspection card										DAIKIN INDUSTRIES, LTD.			
Ship's name			Unit Model			Date of Inspection							
Container No.			Unit No.			Place of Inspection							
Loaded or empty			Loaded cargo			Compressor No.			Customer's staff				
						Service staff							
No	Result			Check point	Check method	Reference valve							
	DECOS	WKM	RMC										
check before operation	1				External appearance and installation of unit (doors, equipment mount, damaged points)	Visual							
	2				Cleaning interior and exterior of unit	Visual							
	3				Checking smudge of unit (air cooled condenser, evaporator)	Visual							
	4				Checking penetration between inside and outside of unit	Visual							
	5				Checking leakage of gas and oil on refrigerant circuit (mainly at joints)	Gas defector							
	6				Checking external appearance of power cable and plug	Visual							
	7				Cleaning drain hose	Visual		Shall be free from clogging					
	8				Mounted condition of electric heaters	Visual		Make sure that leads are not in contact with heaters					
	9				Cleaning defrost air hose and checking that there is no trap on it	Visual		Shall be free from clogging					
	10				Checking appearance of firestat	Visual		Shall have no damaged part					
	11				Checking appearance of over heat thermistor	Visual		Shall have no damaged part					
	12				Tightened condition of cable glands and monitoring receptacle	Retighten		Make sure that they are firmly tightened					
	13				Checking installation bolt of compressor, fan and fan motors	Retighten with tool		Make sure that they are firmly tightened					
	14				Clearance between fan and fan guide	Visual		Shall be kept suitable clearance					
	15				Sealing at control box, and P.S box, etc	Visual		Packing and sealing Shall have sufficient contact					
	16				Slackness of electric terminals and appliance installation	Visual, driver							
	17				Thermal injury of contactors, relays, and coils	Visual							
18				Insulation resistance	Compressor circuit <input type="checkbox"/> MΩ Electric heater circuit <input type="checkbox"/> MΩ Evaporator fan motor circuit <input type="checkbox"/> MΩ	DC 500V megger		2MΩ or more					
19				Checking operation of defrost initiation air switch		Check with manometer		5HP 20mm H <sub>2</sub> O CUT IN 7 1/2HP 25mm H <sub>2</sub> O CUT IN.					
Check during operation	20				Checking operation of oil pressure switch		Confirm normal function during running		1.0 kg/cm <sup>2</sup> 0.5 kg/cm <sup>2</sup> (110Sec. at 25 C)				
	21				Checking noise and vibration of compressor, fans and fan motors		Touch and listen						
	22				Checking circulating refrigerant		Check liquid indicator		Make sure that it is filled				
	23				Checking water ingress in refrigerant		Check liquid indicator		Green...sporlan/Deep blue...Aico				
	24				Checking compressor oil level (operating condition)		Check at compressor oil level gauge		⊖ (Oil level 1/4 ~ 3/4)				
	25				Checking operation of controller and pilot lamps		Check with changing temperature setting and check pilot lamps						
	26				Checking accuracy of recorder (at inside temperature 0°C)		Measuring temperature with controller or thermometer						
	27				Confirming function of recorder and battery		Visual or check with battery checker						
	28				Checking manual defrosting operation		Manual defrost switch or test switch on controller						
	29				Electric heater Operation and current R <input type="checkbox"/> S <input type="checkbox"/> T <input type="checkbox"/>		Clamp meter						
	30				Checking function of defrost termination		Visual (lamp or controller)						
	31				Unit operation current R <input type="checkbox"/> S <input type="checkbox"/> T <input type="checkbox"/>		Clamp meter -18 C <input type="checkbox"/> V <input type="checkbox"/> Hz						
	32				Checking operation of dual pressure switch	H-CUT OUT <input type="checkbox"/> kg/cm <sup>2</sup> L-CUT OUT <input type="checkbox"/> mm Hg L-CUT IN <input type="checkbox"/> kg/cm <sup>2</sup>	Blind air inlet		20 kg/cm <sup>2</sup>				
	33				Checking operation of water pressure switch	Checking switch over from water-cooled to air-cooled operation Checking switch over from air-cooled to water-cooled operation	Accomplish pump down by use of the stop valve at the accumulator receiver or water cooled condenser		40 mm Hg 0.2 kg/cm <sup>2</sup>				
	34				Checking voltage change over	Checking 200V class operation Checking 400V class operation	Disconnect water coupling		Condenser fan motor shall operate				
	35				Inside temperature C <input type="checkbox"/> 0 C <input type="checkbox"/> Ambient temperature C <input type="checkbox"/> LP kg/cm <sup>2</sup> <input type="checkbox"/> HP kg/cm <sup>2</sup> <input type="checkbox"/>	Operating time Immediately after operation Operation Starting <input type="checkbox"/> Hr <input type="checkbox"/> M Operation Starting time <input type="checkbox"/> Hr <input type="checkbox"/> M	Turn voltage selector lever upward (LKE TYPE) downward (LK TYPE) Turn voltage selector lever downward (LKE TYPE) upward (LK TYPE)		Automatic operation at -18 C in one cycle COMP. OFF <input type="checkbox"/> M COMP. ON <input type="checkbox"/> M				
	36				Checking automatic defrosting	Defrost time <input type="checkbox"/> M	Push the "DEFROST TEST" _ defrost starts (out-range : 14sec (DECOS ONLY) after taking (in-range : 43sec.						
	37				Place new chart								
	38				Close control box and PS. box, etc.								
39				Record details of service on history cards									

## 8. How to maintenance

### 8.1 Handling method of the stop valve

#### (1) Place of the stop valve and its kind

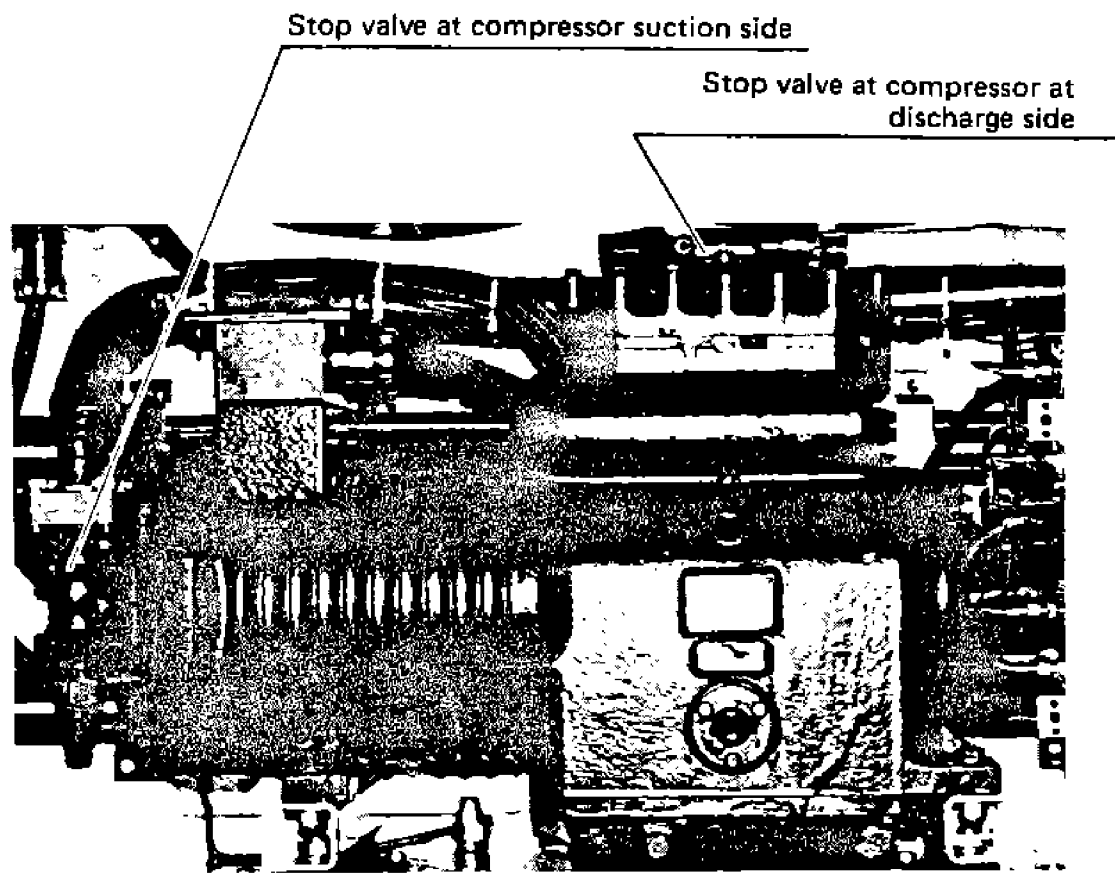

Stop valve at accumulator-receive outlet side

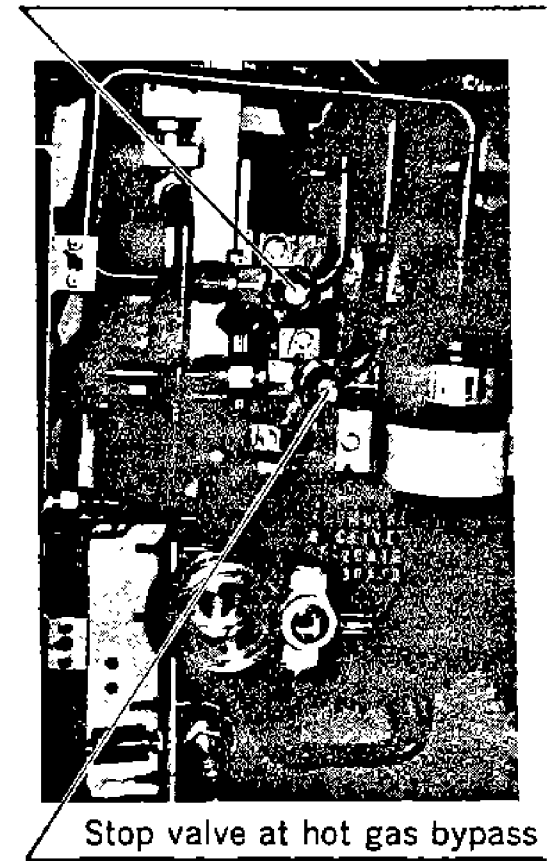

#### (2) Structure of stop valve

1 Stop valve at compressor suction side (VSH26HL)

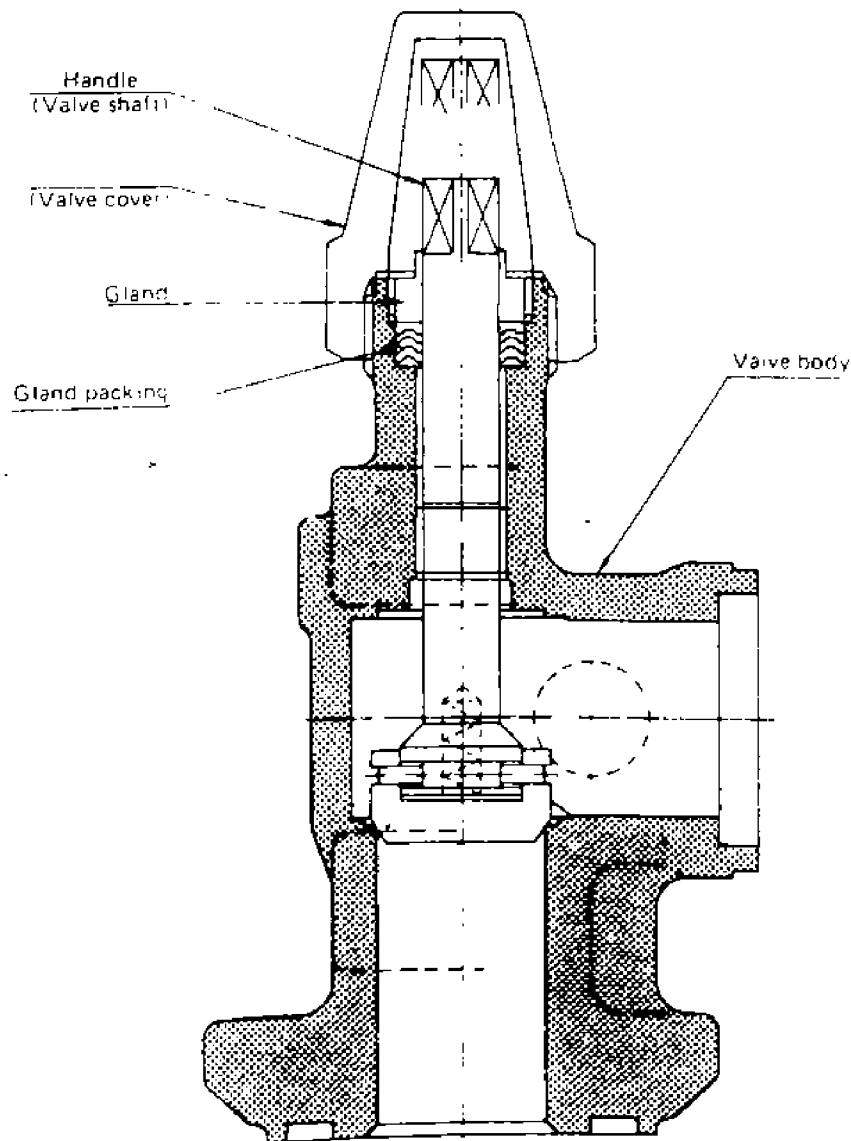

2 Stop valve at compressor suction side (VSH22XBP)

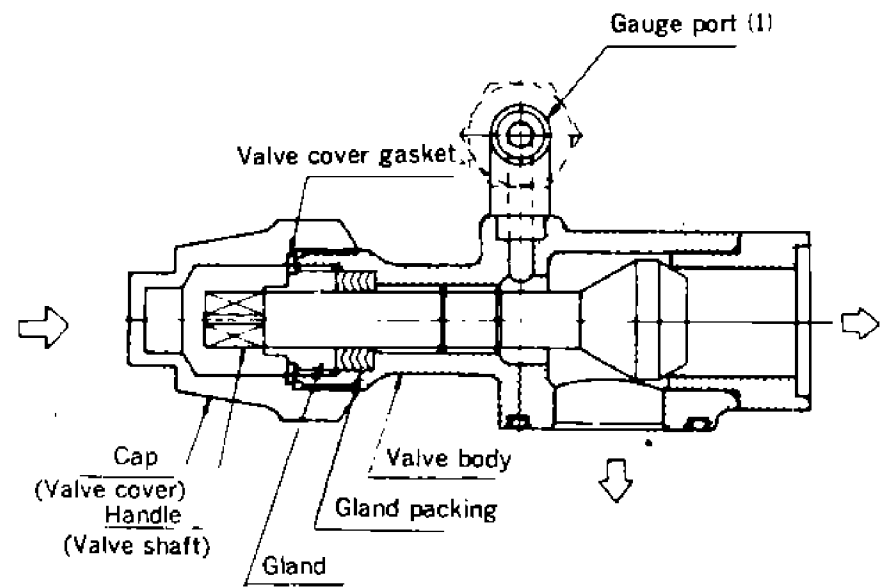

3 Stop valve at accumulator-receiver with heat exchanger outlet side  
Stop valve at hot gas bypass (VSH10CBP-4S-4F)

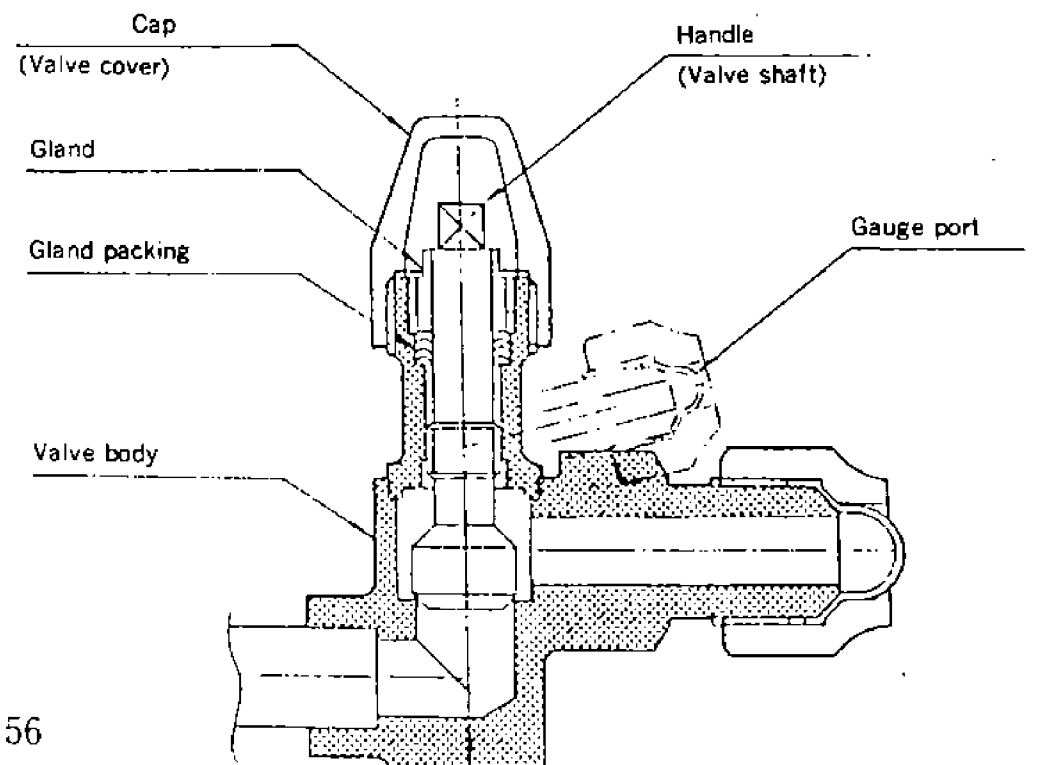

(3) Handling method

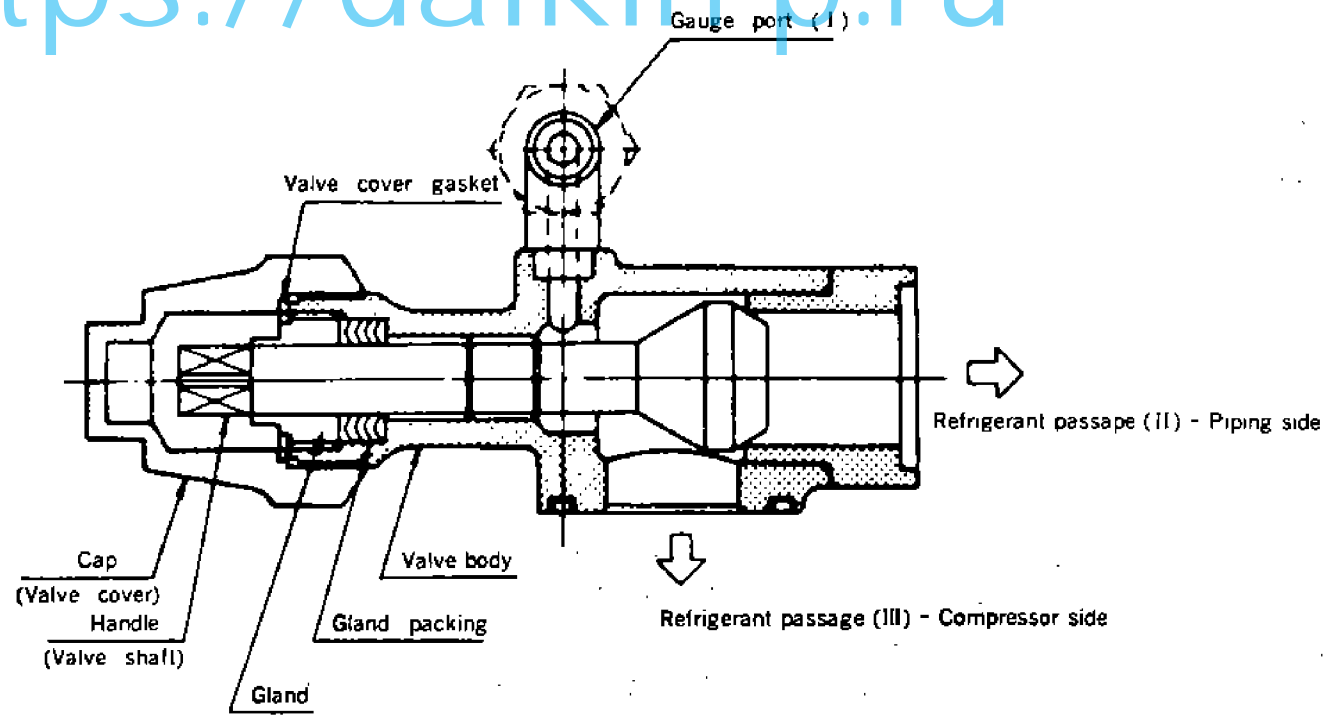

- 1) Remove the valve cap. At this time, be careful not to lose the gasket.
- 2) Loosen the gland in a way the refrigerant is not extracted.
- 3) Fully close the handle .....The refrigerant passage I is connected to III (Front seat)
- 4) Fully release the handle.....The refrigerant passage II is connected to III (Back seat)
- 5) Set the handle at the neutral position .....The refrigerant passage I is connected to II and III.
- 6) The refrigerant passage differs with the procedure mentioned in 3,4, or 5. So select the best passage by necessity.
- 7) Operate the handle, tighten the gland and place the valve cap as it was after completion of the work. At this time, do not forget to attach the gasket.

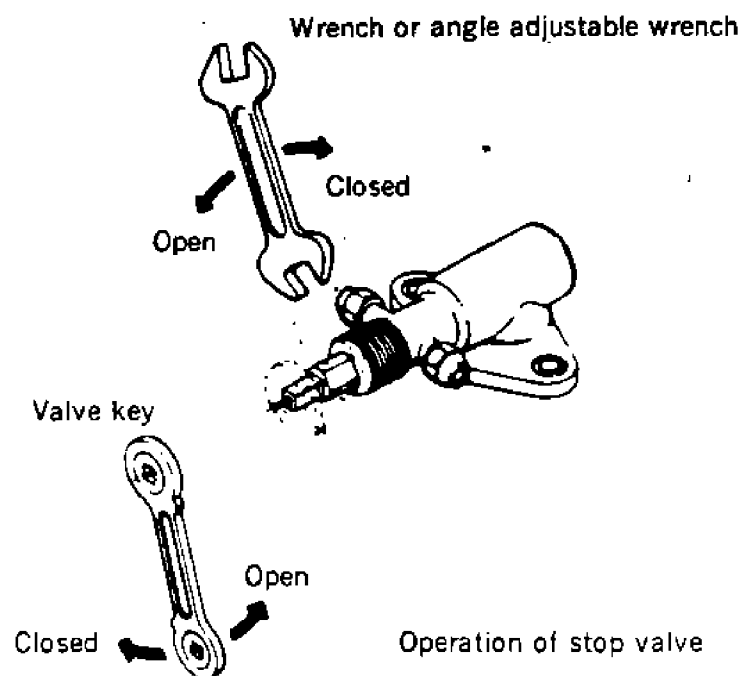

**8.2 Attaching or removing points of pressure gauge**

**(1) Attaching a general pressure gauge**

- 1) After opening the compressor suction valve and the accumulator-receiver valve fully (back seat), connect a pipe to the gauge port.
- 2) Loosen a little the flare nut on the pressure gauge side and tighten the handle of the stop valve a little (Middle seat) and return it at once. Thus the air is purged.
- 3) After purging the air, accurately tighten up the flare nut on the pressure gauge side.
- 4) Close the handle of the stop valve a little, and confirm that the needle of the gauge rises.
- 5) Be certain that the needle of the pressure gauge does not oscillate during the operation of the unit. If it oscillates, do not close the gauge port fully and open the handle of the stop valve a little.
- 6) In case the pressure gauge is attached to the low pressure side, if the low pressure is lower than the atmospheric pressure, the air is drawn in the piping during the air purging. So install the pressure gauge after confirming that low pressure is higher than the atmospheric pressure.
- 7) Operate the unit and confirm that the unit is stopped without pump down.

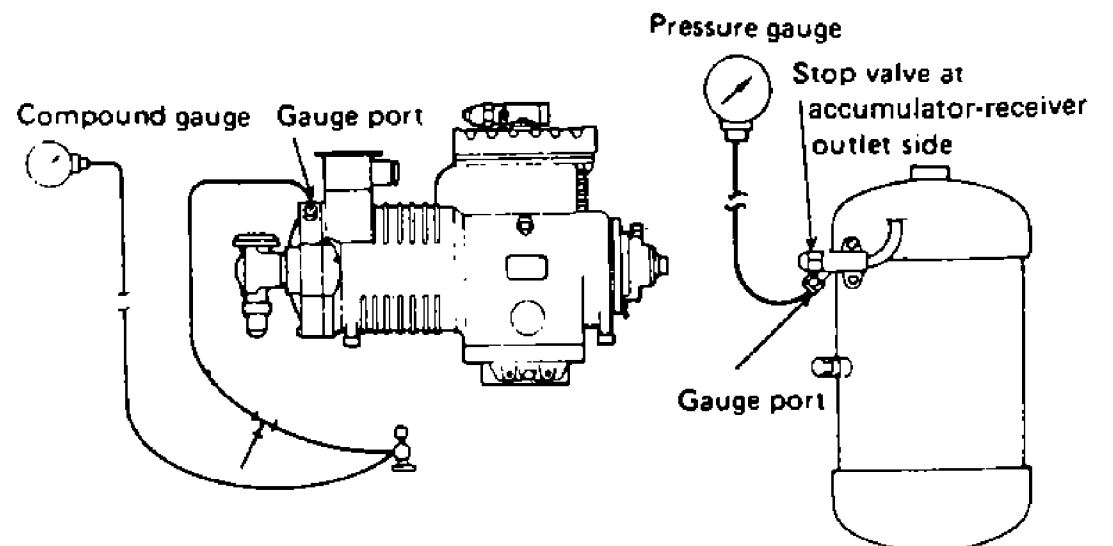
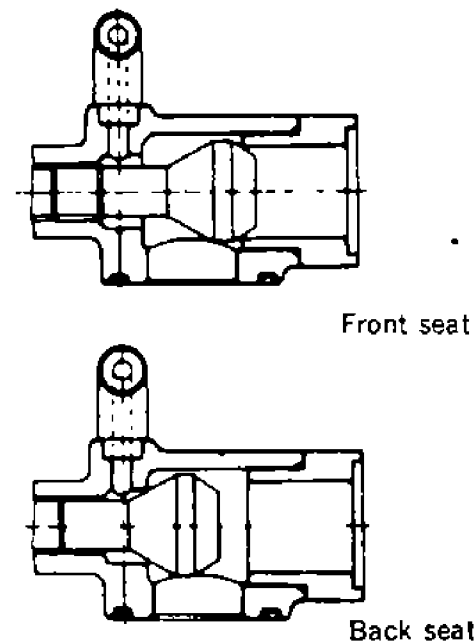

**(2) Attaching the gauge manifold**

- 1) With regard to mounting points, note the same caution as that for general pressure gauges.
- 2) Open the cocks which are attached to the both sides of the gauge manifold when mounting, Loosen the blind cover of the centre hose, and close the gauge port for the compressor suction valve and the accumulator-receiver outlet valve. (Back seat)
- 3) Attach the flare nut of the hose of the manifold on the high pressure side tightly and on the low pressure side loosely.
- 4) Loosen the accumulator-receiver outlet valve and vent the air from the hose on the low pressure side and the centre hose and then once again keep the stop valve in the back seat state. After that, tighten up the flare nut on the low pressure side.
- 5) After closing the cocks of the gauge manifold, keep the cock of the compressor suction valve and accumulator-receiver outlet valve at the neutral seat and measure pressure.

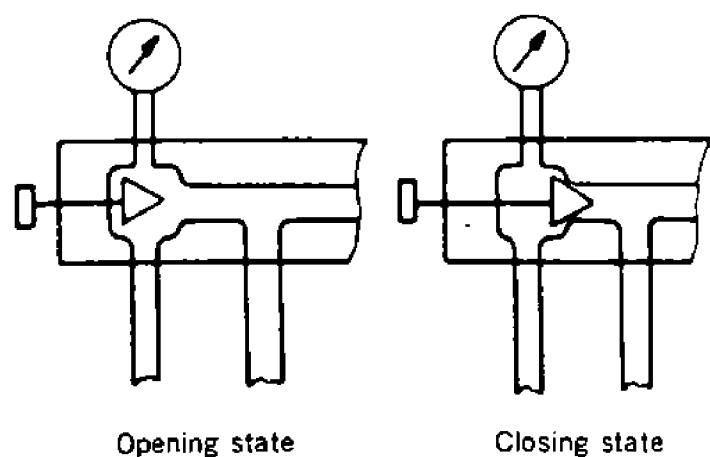
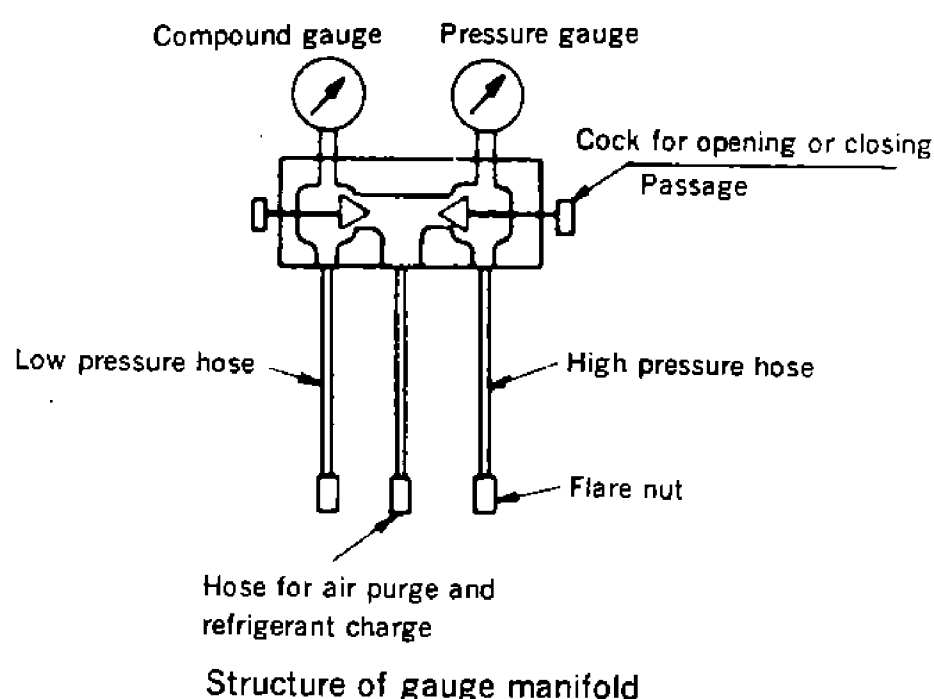

Opening and closing states of gauge manifold

**(3) Removing the pressure gauge and the gauge manifold, as stated below.**

When the high pressure hose is removed, note that the liquid refrigerant in the hose may jet out, which is very dangerous.

- 1) Hold the handle of the stop valve in the back seat state, and close the gauge port.
- 2) Open the cock (in case of gauge manifolds) or the flare nuts (in case of general pressure gauges) a little to extract the refrigerant from the hose.

At this time, do not open it suddenly so as not to jet out liquid refrigerant.

- 3) After extracting the refrigerant from the hose, remove the pipe connection for the gauge piping.
- 4) Place the blind cover on the gauge port of the stop valve, accurately tighten up the flare nut and confirm no refrigerant leaks.

Note: Since the blind cover is very small, be careful not to lose it.

**8.3 Pump down**

Pump down means that the refrigerant in the refrigeration circuit is liquidized and collected in the Accumulator-receiver with heat exchanger, This work is required to repair the refrigeration circuit for minimizing leaking volume of the refrigerant and risks due to pressure rising.

<Working procedure>

- 1) Install pressure gauges to the high pressure side the low pressure side.
- 2) Operate the refrigeration unit (either on water cooled or air cooled operation)
- 3) Close the accumulator-receiver outlet valve.
- 4) Stop the operation when reading of the low pressure gauge becomes 0.1 kg/cm<sup>2</sup> and close the compressor discharge valve.
- 5) After a short while, read the low pressure gauge. If pressure rises, open the compressor discharge valve and repeat the same procedure.
- 6) Repeat the same procedure two or three times, and the refrigerant is collected in the accumulator-receiver with heat exchanger. If no pressure gauge is attached, the unit is stopped by the low pressure setting of the dual pressure switch.

## 8.4 Charging and purging the refrigerant

### (1) Purging non-condensable gas

If non-condensable gas such as air exists the refrigeration circuit, it is collected by the accumulator-receiver with heat exchanger, which raise pressure in the accumulator-receiver with heat exchanger abnormally high and reduces heat transferring ratio of the condenser surface. It is, therefore, very important to extract non-condensable gas.

If discharge pressure is abnormally high (even though cooling water volume is increased, in case of water cooled operation) and will not return to the normal pressure, inspect if non-condensable gas such as air exists with the following method.

- Stop the compressor, close the accumulator-receiver outlet valve and wait until leaving and entering cooling air (or water) of the air (water)cooled condenser become equal. If there is any difference between saturated pressure corresponding to cooling air (water) and condensing pressure, non-condensable gas exists. In this case, purge non-condensable gas as stated below.

- 1) Accomplish pump down
- 2) Condense the refrigerant as much as possible, and then discharge it from the gauge port of the compressor discharge valve.
- 3) Discharge the condensed refrigerant repeatedly reading the pressure gauge until condensing pressure becomes saturated pressure.

### (2) Refrigerant purge

There are two methods of refrigerant purge; i.e. one is for collecting the refrigerant extracted in a cylinder and the other is for discharging it to the atmosphere.

#### (a) Collecting the refrigerant in a cylinder

- 1) Prepare an empty cylinder which has been dried by forming vacuum inside and weigh it.
- 2) The cylinder is connected to the gauge port of the Accumu-receiver with heat exchanger by piping with the cylinder cock closed, and then loosen the flare nut on the cylinder side a little to vent the air from the piping.
- 3) Operate the refrigeration unit to pump down the refrigerant.
- 4) After completion of pump down, open the gauge port of the accumulator receiver with heat exchanger and then open the cock of the cylinder to collect the liquid refrigerant into the cylinder.
- 5) After collecting the refrigerant, close the gauge port and the cock and then remove the piping.
- 6) Be certain that the refrigerant has been collected in the cylinder by weighing it.
- 7) As for the refrigerant remaining in the refrigeration circuit, extract it to the atmosphere.

#### (b) Extracting the refrigerant to the atmosphere

- 1) Open the gauge port on the suction side of the compressor to extract the gaseous refrigerant to the atmosphere.
- 2) Do not open the compressor discharge valve or the

gauge port of the accumulator-receiver with heat exchanger, otherwise the refrigerant oil and the liquid refrigerant are discharged, which may result in shortage of oil or getting chilblain.

- 3) Do not extract the refrigerant in a closed room and also confirm there is no fire around it. Although the refrigerant is non-toxic, there may be fear of suffocation. In addition, if the refrigerant contacts with fire, it yields phosgene gas (toxic gas).

### (3) Vacuum drying and charging refrigerant and refrigeration oil

If all the refrigerant has leaked out and the air is intermixed in the refrigeration circuit, repair a cause of trouble and do vacuum drying. Then charge the predesigned volume of refrigerant. In case the refrigerant oil is replaced, do the same.

(Required tools)

1. Refrigerant cylinder (20kg) for R-12 (CC12F2) with mouth piece
  2. Refrigeration oil (20 l can) SUNISO 3GS-DI
  3.  $\phi 6.4$  CuT (with two flare nuts)
  4. Pressure gauge (20kg/cm<sup>2</sup>), compound gauge (10kg/cm<sup>2</sup> × 75cmHg) } or gauge manifold
  5. Weighing scale (Up to 50 kg)
  6. Tools
  7. Vacuum pump
- (a) In case the refrigerant is replenished without exchanging the refrigeration oil.
- 1) Connect the vacuum pump to the gauge ports of the compressor suction and discharge valves, form vacuum down to 76cmHg, hold the stop valve in the back seat state and then remove the vacuum pump, leaving the vacuum state in the refrigeration circuit. However, when air enters in the refrigeration circuit, form the vacuum in the circuit down to 76 cmHg and leave it for more than 2 hours (vacuum drying).

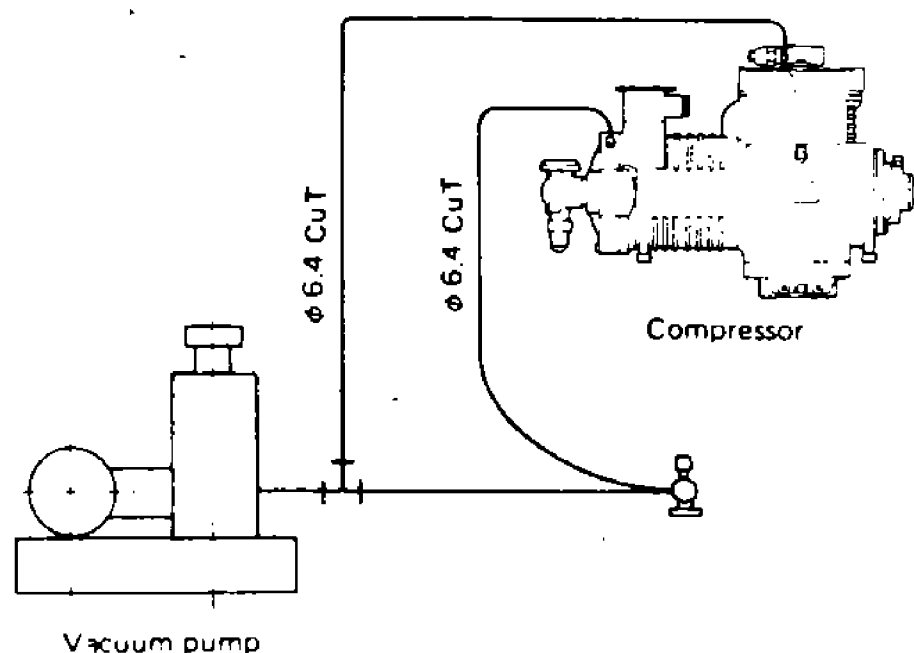

- 2) To evacuate the refrigeration circuit between the solenoid valve and expansion valve, reduce pressure of the circuit below the preset level of the low pressure switch lower the presetting level of the set point selector, operate the refrigeration unit, and open the solenoid valve for evacuation. At this time (vacuum drying), the compressor remains idle since the low pressure switch is off, and the solenoid valve alone open.

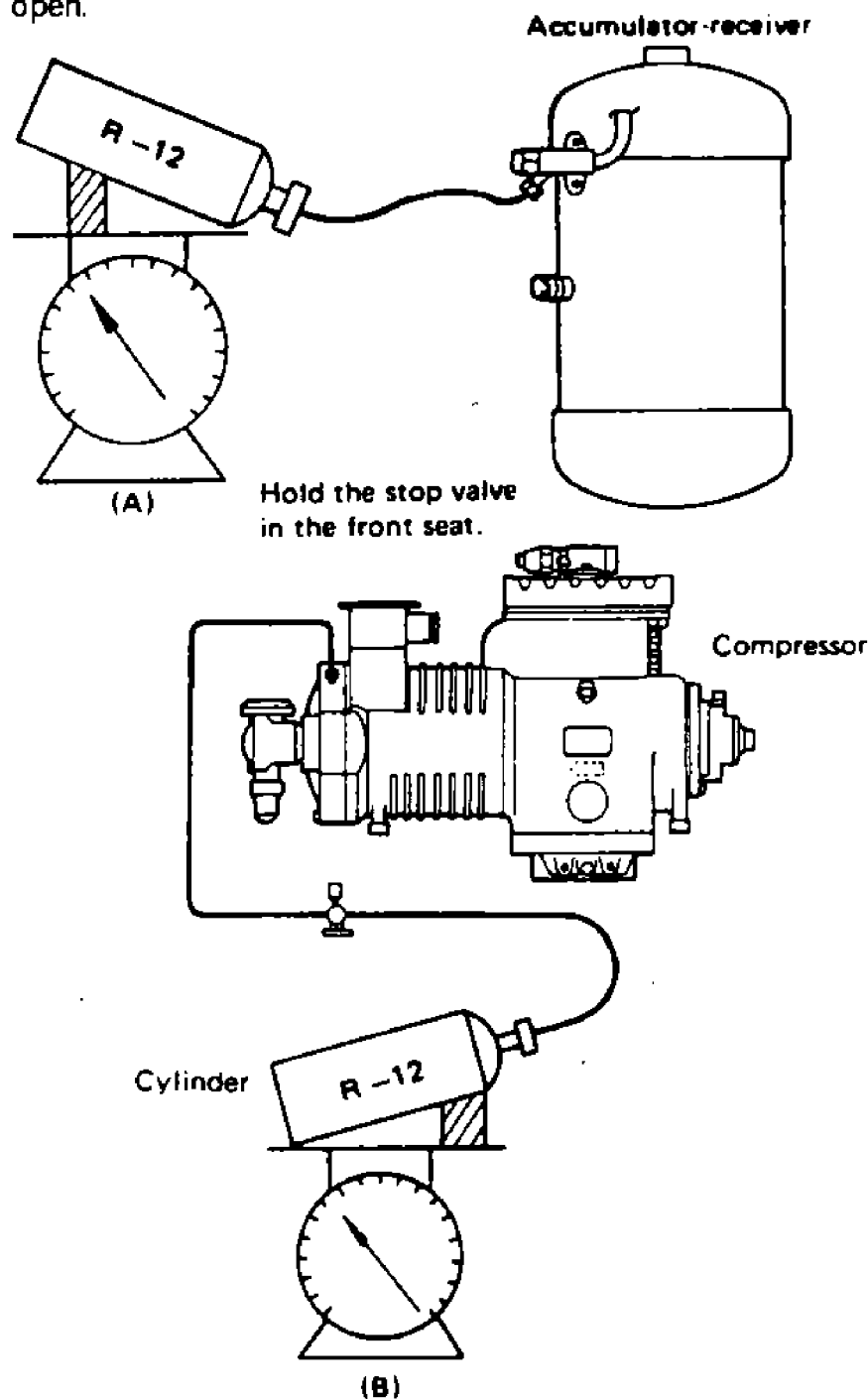

- 3) Place a refrigerant cylinder on the weighting scale, and record its weight.
- 4) In case the refrigerant is charged in the liquid state, do it as shown in the above figure (A). Prevent the liquid refrigerant collected in the accumulator-receiver with heat exchanger from flowing to the low pressure side. If the refrigerant is hardly charged, operate the compressor to charge it.
- 5) In case the refrigerant is charged in the gaseous state, do it as shown in the above figure (B). If the refrigerant is hardly charged, operate the compressor to charge it.
- 6) Charge the predesigned volume of the refrigerant in the above stated methods either in 4 or 5.
- 7) After completion of refrigerant charge, hold the stop valve in the back seat state and confirm that if the predesigned volume of the refrigerant has been charged by operating the refrigeration unit.

- (b) Charging the refrigerant as well after replenishment of refrigerant oil

- 1) Extract the refrigerant oil. → Firstly discard all the gas so that pressure in the refrigerant circuit becomes 0. Then loosen the drain plug at the bottom of the compressor to extract all the oil. At this time, firstly open the oil charge plug and then the drain plug to prevent the oil from jetting out.

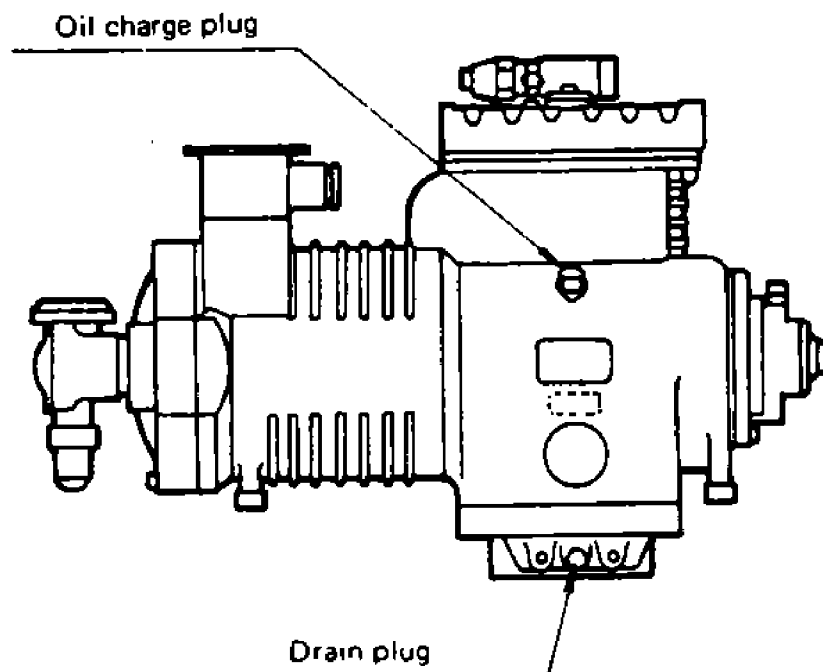

- 2) Tighten up the drain plug.
- 3) Charge the predesigned volume of the oil from the charge plug of the compressor.
- 4) Accomplish vacuum drying and refrigerant charge stated in (1).
- 5) Be sure to stop the compressor while this work is accomplished.
- 6) When the refrigeration oil is discarded, be sure to remove the oil level gauge for cleaning.
- 7) Recommendable refrigeration oil is SUNISO 3GS-DI. SUNISO 3GS-DI is superior to SUNISO 3GS in heat resistance. Maker of SUNISO 3GS-DI is SUN OIL CO., LTD. (U.S.A)
- 8) Do not mix two refrigeration oils.
- 9) Do not use oil which is left opened to the atmosphere for a long time, as it may contain water. In case oil still remains in the oil can after charging, be sure to cap it.
- (c) In case only the refrigeration oil is exchanged.
  - 1) Operate the refrigeration unit to pump down the refrigerant by use of the stop valve at the outlet of the accumu-receiver with heat exchanger and stop it when low pressure becomes 0.1Kg/cm<sup>2</sup>.
  - 2) Tighten up the discharge valve of the compressor.
  - 3) Open the gauge port on the suction side to extract the refrigerant on the low pressure side.
  - 4) Charge the oil from the oil charge plug. At this time, form the vacuum gradually to hasten oil charge.
  - 5) Tightening the oil charge plug, form the vacuum and dry the compressor.
  - 6) Restore the stop valve to its original state.